

# FAST

AIRBUS  
TECHNICAL  
DIGEST

NUMBER 5  
MAY 1985



# FAST

**AIRBUS  
TECHNICAL  
DIGEST**

**NUMBER 5  
MAY 1985**

**2**

## **THE MODERN WING OF THE A310**

ADRIAN MARX - SWISSAIR

**12**

## **FUEL CONSERVATION PART 5**

DESCENT AND LANDING OPERATIONS  
AIRBUS SPECIALISTS

**16**

## **INTERFERENCES**

ALAIN LEPICARD

**20**

## **FLIGHT CONTROL SYSTEM**

BERNARD ZIEGLER - MICHEL DURANDEAU

**26**

## **FQI SYSTEM**

INSTALLED ON A300-600 & A310  
HANS FISCHER

**30**

## **AIRBUS FIELD SERVICE INFORMATION**

**32**

## **WHAT IS IN A WING?**

### **NOTE**

To help our readers identify subsequent issues of FAST, we have decided to adopt a numerical identity system. Two editions were issued in 1983 and 1984, therefore this edition is No 5.

Cover : Detail of a board in the digital Fuel Quantity Indicating computer on the A300.

The articles herein may be reprinted without permission except where copyright source is indicated, but with acknowledgement to Airbus Industrie. Articles which may be subject to ongoing review must have their accuracy verified prior to reprint. The statements made herein do not constitute an offer. They are based on the assumptions shown and are expressed in good faith. Where the supporting grounds for these statements are not shown the Company will be pleased to explain the basis thereof.

Publisher : Airbus Industrie, Flight & Support Directorate  
F-31707 Blagnac Cedex. Telephone (61) 933333, Telex AIRBU 530526F  
General Editor : Denis Dempster, Technical Director : Gérard Misraï  
Graphic Design : Knut Marsen / Agnès Lacombe  
Printing : Escourbiac F-81306 Graulhet  
©1985 Airbus Industrie

# THE MODERN WING OF THE A310



**Adrian Marx**  
Manager Aircraft Performance  
Swissair

The wing of our new A310 aircraft is a very refined example of modern wing design for transport aircraft. This article offers some general insight into the thinking behind the development

of such a wing mainly from the aerodynamics point of view. The A310 is the latest addition to the family of transport aircraft from Airbus Industrie, using a shortened version of the A300 fuselage to offer a capacity of about 210 passengers on a new wing. The development of the modern wing of the A310 (see Figure 1) represents a major milestone in the history of European transonic wing design. Initial project studies for the A310 explored options including the use of the A300 wing with and without modifications, but several factors, in particular the greatly increased price of fuel, resulted in a decision to use

a completely new wing of reduced size for the A310. The new airliner was given the go-ahead signal in July 1978 and after Britain became a full partner of Airbus Industrie in November the same year, British Aerospace (BAe) Hatfield, Chester Division, was contracted for the design and production of the A310 wing, this after much discussion of the merits of competitive French and German wing designs. But it was a logical choice since BAe had already developed the successful A300 wing and its production facility at Chester is equipped with the necessary large milling and riveting machines. Many factors have an influence on the ultimate success of a transport aircraft. The question arises, for example, what shape an aircraft should have to offer the desired qualities?



Since the dawn of human history man's thinking on how to fly has been dominated by wanting to imitate the birds. In the late fifteenth century Leonardo da Vinci devoted a considerable effort to develop humanpowered flapping wing designs (ornithopters), which never had a chance of succeeding. The shape of the airplane as we know it today has its beginnings in the realization that we should copy the soaring birds rather than the flapping ones. Long before Lilienthal flew his first glider in 1891 and the Wright brothers accomplished the first flight in a powered aircraft (1903), it was Sir George Cayley (1773-1857) an English nobleman and the true inventor of the airplane who, in 1799, proposed for the first time the concept of the classical type of airplane with a fixed wing for generating lift, a separate mechanism for propulsion (Cayley contemplated paddles), horizontal and vertical tail surfaces to provide the forces necessary for control and space for the payload. His idea of separating the functions

by having largely independent organs to fulfill them was well adapted to the possibilities of human engineering. He published them in papers (1809/1810) which were the first recorded treatise on theoretical and applied aerodynamics. In 1853 Sir George built a glider which is now assumed to have flown for a few hundred meters across a dale carrying his coachman, who then immediately resigned to avoid having to repeat the experience. When in 1903 Wilbur and Orville Wright attained powered flight with a practical and controllable airplane no theory existed that would explain the amount of lift obtained experimentally with a curved surface at zero angle of inclination to the airfoil chord line. Quite a gap separated the empirical observations and the theoretical calculations for actual lift. The predominance of empirical aerodynamics, which characterized the first 20 years of flight, ended with the publication of the 'Wing Theory' by Ludwig Prandtl (1875-1953) which together with his ingenious concept of the boundary layer earned him the title of 'Father of Aerodynamics'. Conceptually the classical type of straight-winged aircraft reached

its final, streamlined form around 1930. A significant extension came about when the German aerodynamicist Albert Betz and others pointed out the advantages of the swept wing in the early forties. This is the planform shape of the wing that we apply for higher subsonic cruise speeds to this day, although with much more refined airfoils.

**Figure 1**

Wing Planform Comparison		
Aircraft	A300	A310
Wing area	260 m <sup>2</sup>	219 m <sup>2</sup>
Wing span	44.8 m	43.9 m
Aspect ratio	7.71	8.8
Sweepback	28°	28°

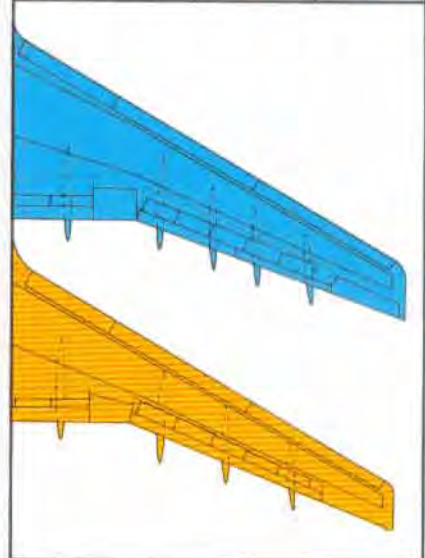

To a large extent the whole concept for a new aircraft stands or falls with the quality of the aerodynamic design of the wing and ultimately with achieving the required standards in flight.

First back to some basics - what do we expect the wing to do?

The wing must furnish the lift to support the weight of the aircraft structure, fuel and payload, while flying in cruise safely with maximum efficiency at high subsonic speeds.

To illustrate the contribution which aerodynamics makes towards the most efficient aircraft to get us from A to B, we can look at the major parameters which influence the fuel required per unit payload per unit distance. As a figure of merit it depends on :

wing designer starting from scratch, many characteristics and trade-offs will have to be settled ; some of which are listed here : wing area, planform, aspect ratio (the proportion of the span to the average chord; this is the fineness ratio of the wing with values varying from 20 to 35 for high-performance sailplanes, 2 to 3 for jet fighters and 7 to 9 for jet transports), sweep angle and airfoil shape.

Besides the performance requirements there are also operational and flying quality aspects to be observed. These include acceptable handling of the aircraft prior to and during the stall, and at the high speed end the boundary of buffet on-set. It is obvious that designing a wing is a tremendous task requiring

same as for the A300, thus minimizing changes if direct comparisons were to be useful.

When a wing develops lift, it also develops drag due to lift - the induced drag - which would increase as aspect ratio or span are reduced. Therefore when choosing the planform it seemed best to leave the span about where it was and decrease the area as much as possible by making the wing more slender, that is, increase the aspect ratio. The reduction in area (16% less than for the A300) also helps in reducing the basic friction drag of the wing and has a beneficial effect on production costs. However, this means that every unit of wing area has to work harder and develop more lift. To make the new wing worthwhile, a significant improvement over the acknowledged high standard of the A300 wing had to be shown.

How was this accomplished ? BAe points out that it was not a break - through in transonic aerodynamics, it was rather the application of new computational methods and the power of

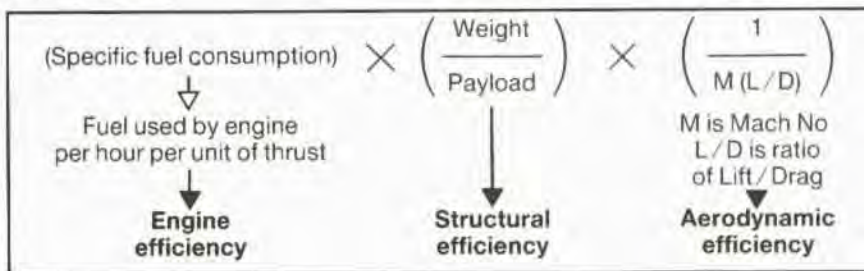

Thus to obtain maximum fuel efficiency, we would like :

1. an engine with thrust determined by cruise considerations and minimum fuel consumption;
2. a light efficient structure to minimise the ratio of aircraft weight to payload;
3. an aircraft with a high lift/drag ratio cruising at the highest possible Mach No. (on the verge of the drag rise) ; conditions determined largely by the aerodynamic design of the wing.

But the wing must also be able to fly slowly enough to take-off and land safely at existing airports and at weights compatible with cruise conditions. There is a fundamental conflict between the design aims for these three flight conditions. The way out of this dilemma is to develop a clean wing for cruise that can readily be transformed into different geometric configurations.

A transport aircraft design will then have three main design points to attend to :

1. take-off and climb-out at  $V_2$  with flaps extended;
2. cruise with a clean wing at a maximum  $M \times L/D$ ;
3. landing with flaps in the appropriate position.

The cruise flight tends to dominate the wing design problem because of the longer times spent in this phase and thus the larger amount of fuel burnt. For a

**Figure 2**

**A310 factors of high speed wing design**

- Basic wing / advanced 2D section / transonic design
- 3D design of inner wing
- Flap drive fairing interference
- Steps / gaps etc. "clean-up"
- Nacelle / pylon / wing interference
- Wing / fuselage interference

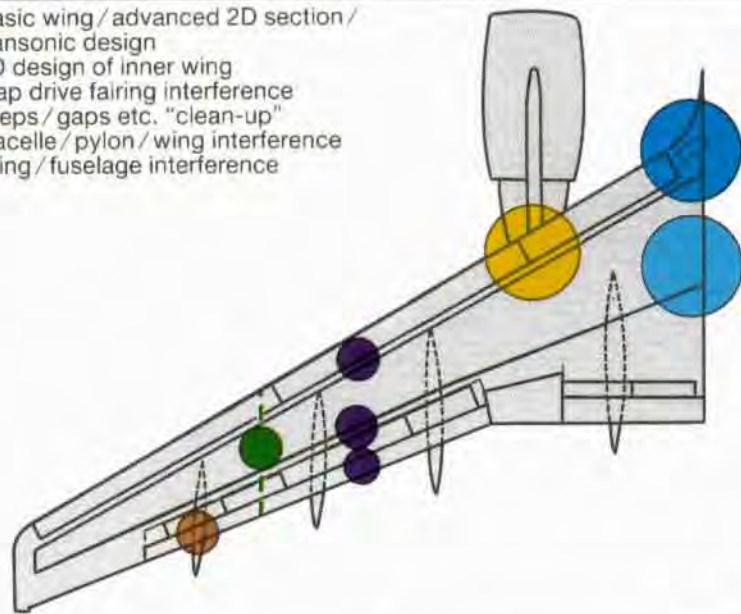

years of effort until the optimum balance of the frequently conflicting parameters is achieved.

The task is so complex that experience makes a vital contribution to the design process ; in our case the lessons learnt on the A300 have been carried forward into the design of the new wing of the A310. The two wings are shown in Figure 1. For the smaller aircraft the new optimized wing was going to be smaller ; the sweep was left the

digital computers. For the first time they were able to compute the mixed supersonic / subsonic flow around a two-dimensional (2D) wing section, and also around the three-dimensional (3D) wing itself.

Building on the experience with the A300, the main factors tackled in the A310 wing design process are shown in Figure 2. We will now have a closer look at two of the items shown in Figure 2, the transonic design of the 2D

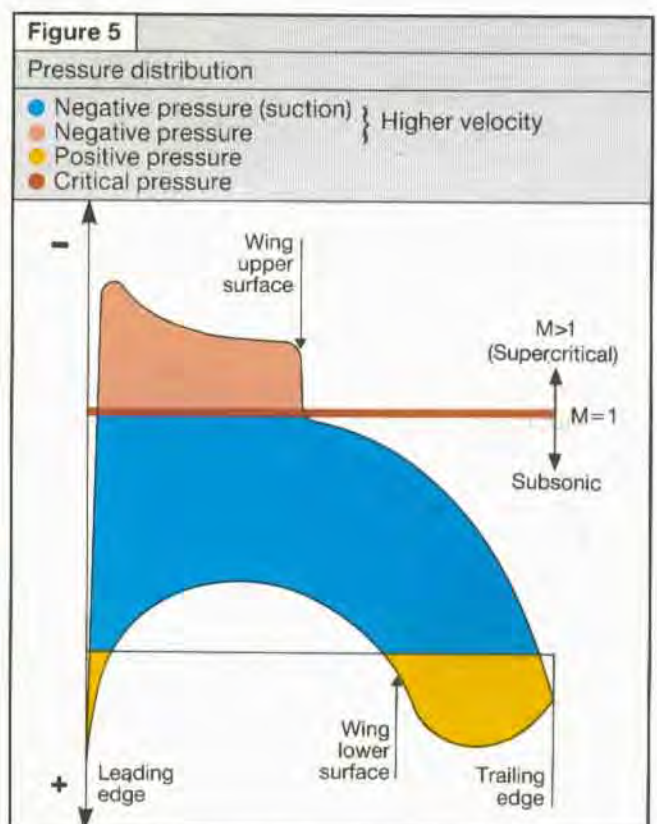
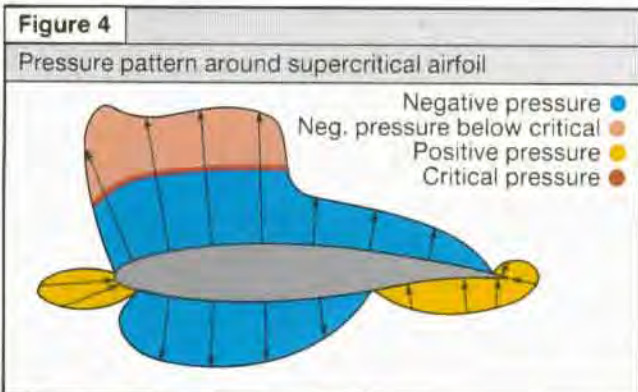
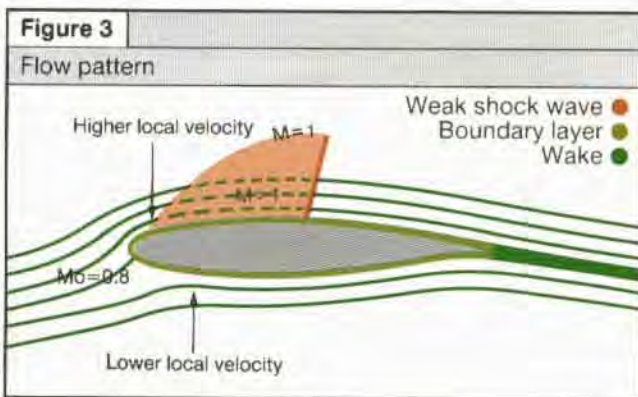

section of the basic wing and the 3D treatment of the inner wing. In the transonic flow regime the flight Mach No. generally ranges from slightly less to slightly greater than 1.

Selection of a wing airfoil starts with a statement of the flight requirement. The design aim is to develop a wing with plenty of lift, not much drag for a given thickness, able to fly at high speed and achieve all this with a healthy attached flow, (separation of the boundary layer would cause extra drag), under all flight conditions.

### AIRFOIL SELECTION (TWO-DIMENSIONAL FLOW)

Looking at Figure 3 we find a modern airfoil shape in a flow with a freestream Mach No. of 0.8. Being above the critical  $M$ , (where the local velocity on the airfoil first goes sonic), it creates an area of supersonic flow ( $M > 1$ ), followed by a weak shock near the crest or top of the section as the only way to bring the supersonic flow back to subsonic. In a practical 2D flow the boundary layer, which has become turbulent early on, has to stay attached to leave the trailing edge in a wake with a minimum of profile drag. Lift is the net force caused by the distribution of pressure over the upper and lower surfaces of the airfoil. Velocities higher than freestream ( $M_0$ ) will mainly create suction pressures (negative pressure = less than

surrounding atmospheric pressure, positive pressure = above surrounding atmospheric pressure) on both upper and lower surfaces, but the upper surface suction must be greater for positive lift.

Figure 4 is a sketch of the pressure distribution on the surface around the same wing section, from the forward stagnation point to the trailing edge, marking off the area where the pressure is lower than critical corresponding to the region of supersonic flow. Figure 5 continues with the same modern supercritical airfoil showing the typical pressure distributions as the aerodynamicist compares them for his 2D flow investigations. Negative values are plotted above the horizontal axis. The colored area between the upper and lower surface pressure distributions is proportional to lift. It is the all-important shape of the airfoil that determines the pressure distribution and thus the amount of lift. Up to the end of World War II a vast amount of research was done in wind tunnels for developing suitable subsonic airfoils. Then priorities for supersonic and hypersonic aerodynamics considerably slowed down work for flight below the speed of sound.

Several centers of research in Europe and the USA had advanced airfoils in this category under development during the 1960's. Before this however, when jet engines were first being installed

and aircraft began to enter the high-subsonic-speed region, it was thought that it was necessary to avoid sonic velocity on the airfoil to escape getting shock-induced separation and the drastic increase in drag that goes with it (Figure 6). But it then became obvious that it was perfectly permissible or even desirable to have considerable supersonic velocity on the forward part of an airfoil to further increase lift. On this basis, design of airfoil shapes progressed rapidly in the 1960's and 1970's, the primary aim being to get as high a lift coefficient with an acceptable shock strength that the boundary layer could tolerate without flow separation and as little drag penalty as possible.

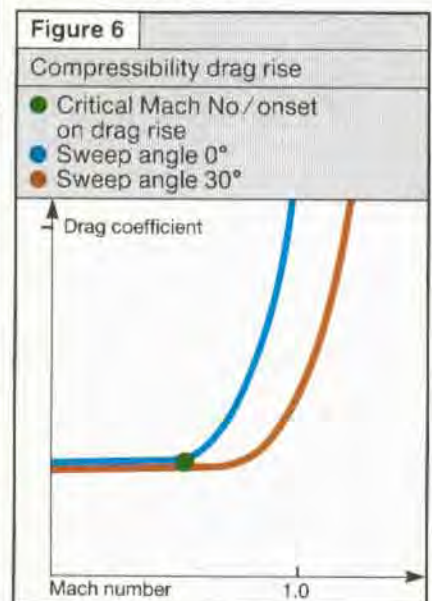

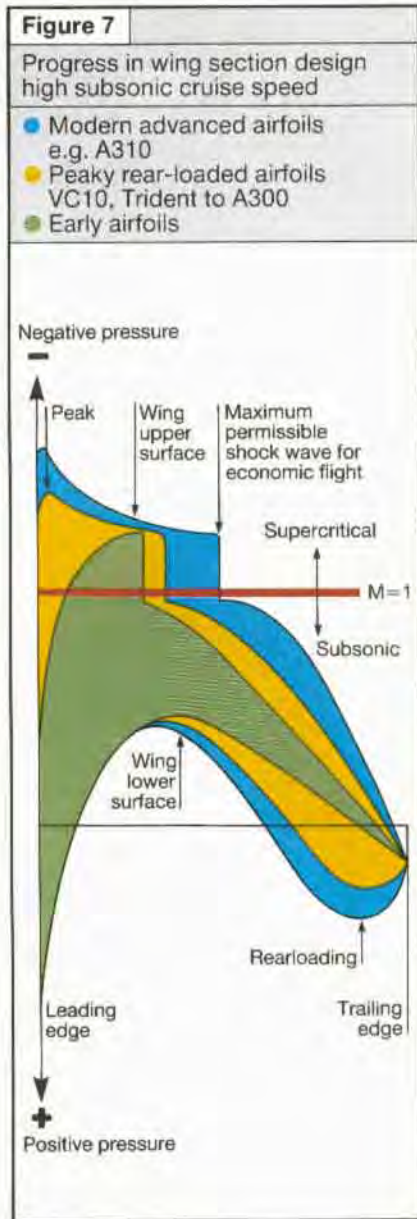

Characteristic is a very small curvature over much of the upper surface and a change in the lower profile contour between the maximum thickness and the trailing edge such that a reduced local thickness is obtained. This last measure allows more load to be carried aft and is known as 'rearloading'. Figure 7 describes the main stages in wing section development for transonic transports in a simplified manner. The early airfoil, designed for the first jet transports when knowledge of transonic flow was sketchy, had little load carried in the supersonic zone and towards the rear. In a second stage advanced transonic airfoils showed up with more load carried in front of the shock and the rear-loading concept incorporated. The modern airfoil for the A310 has the shock pushed further back and yet more rear-loading, giving a further substantial increase of the lift produced by the wing. The superiority of this advanced airfoil over a compar-

able conventional one could be expressed in a similar improvement of the drag rise Mach No. as shown in Figure 6 for the step from a straight wing to a wing of 30° sweep. This gain could either permit greater speed with a given wing sweep and thickness or less sweep and/or greater thickness for a given drag rise Mach No. Higher speed is no longer the objective, rather the conservation of fuel is. By choosing greater thickness we can also reduce the wing weight because more structure height is available at the root where the bending moment is maximum during flight, which leads to a smaller wing area, reduced fuel consumption and eventually lower operating costs.

### THREE-DIMENSIONAL WING

The process of wing design advances through two phases. We first choose a 2D wing section looking at a flow that stays the same in every plane parallel to the longitudinal axis: the flow sees essentially an infinite wing with no wing tips, stretching from plus infinity to minus infinity in the spanwise direction. The follow-on phase uses the 2D airfoil as a basis for the design of the 3D wing. The flow about this finite wing is inherently different from the 2D flow around an infinite wing. On the real wing lift must decrease towards the tips and become zero at the very end as there cannot be a pressure difference between the upper

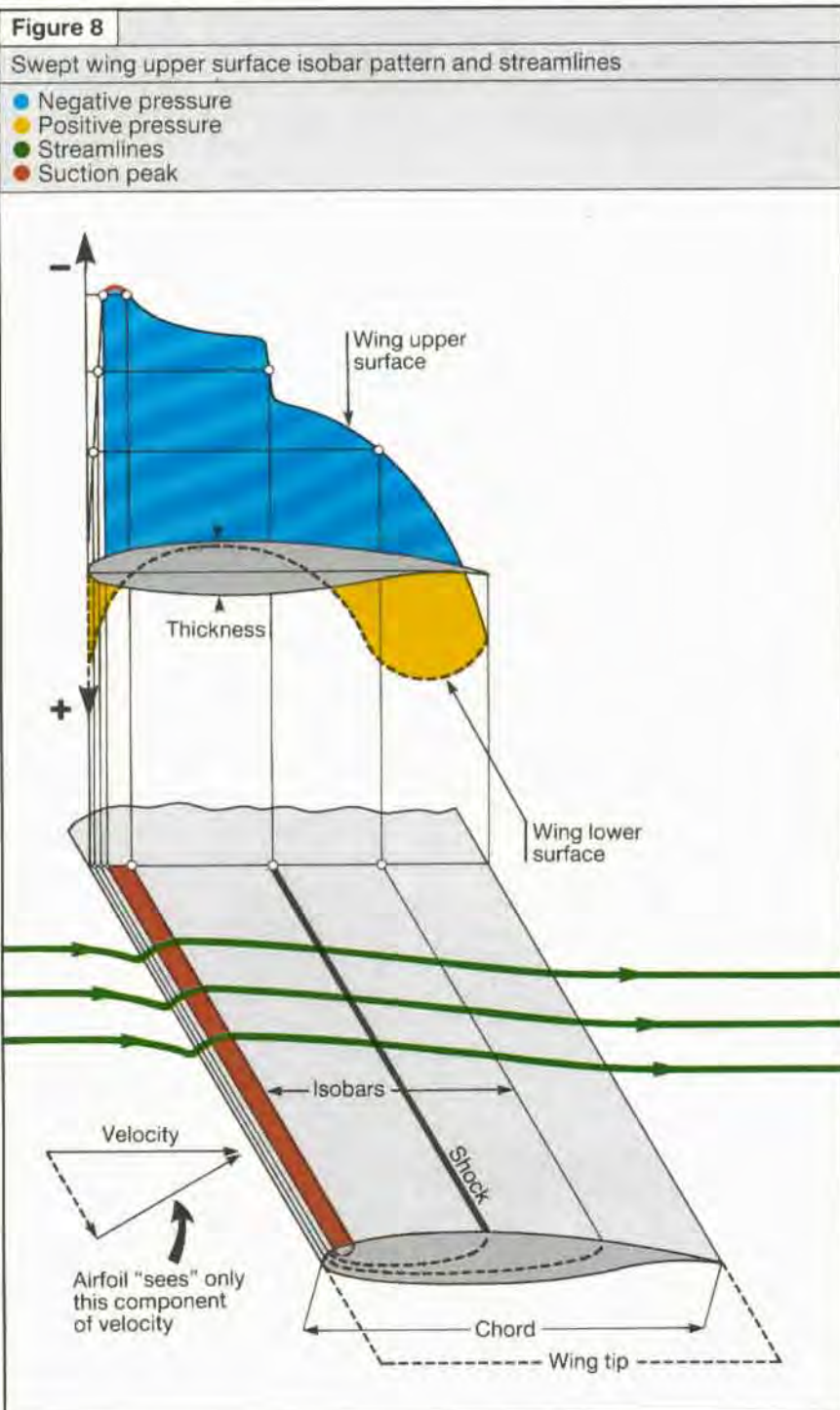

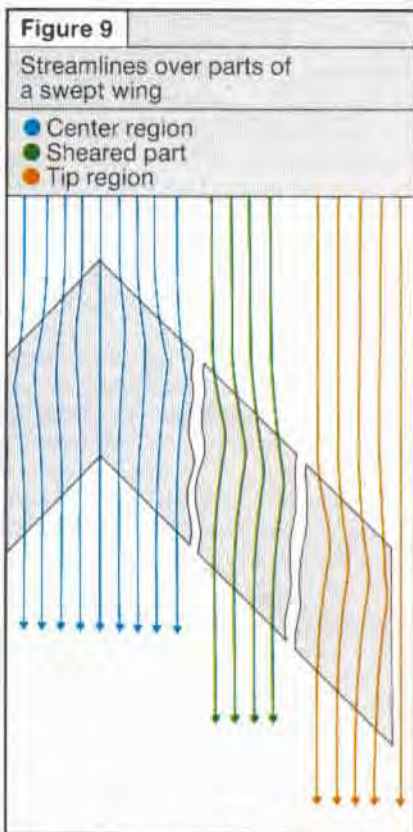

and the lower surface out there. For a short discussion of the advantage of swept wings we first look at the wing without any influence from root or tip. Sweepback raises the Mach No. for the on-set of the compressibility drag rise, (Figure 6), because the airfoil only sees the smaller component of the free-stream velocity perpendicular to the leading edge of the wing, as shown on Figure 8. The section normal to the leading edge is thus the relevant shape and the Mach No. can therefore be raised before encountering critical compressibility phenomena on the airfoil. Sweep is primarily a means for reducing flying time for a given range. Figure 8 also introduces the concept of isobars, lines connecting points where the pressure is the same, here depicting the isobar patterns with suction peak and shock on a swept wing made up of our previously discussed supercritical airfoil, shifted backwards along the span but keeping its shape. On this mid-section of an ideal wing, cut out of an infinite span, the isobars are parallel to the leading edge. We also notice the curved shape dictated by the pressure distribution of this swept wing. The curvature pointing inboard near the leading edge is due to the lower static pressure inboard. In contrast to our idealised infinite swept wing, real 3D finite swept wings have a kink in the middle (ignoring the

fuselage) and this fundamentally affects the flow. The curved streamlines can persist neither into the center for reasons of symmetry, nor out to the wing tip. As indicated in Figure 9, they are straightened out in both regions. These root and tip effects of the 3D wing also bend the isobars, such that they end up more normal to the flow, in fact reducing the sweeping effect (Figure 10). The suction peaks are shifted backwards near the root (increasing drag) and forwards, but not as much, near the tip.

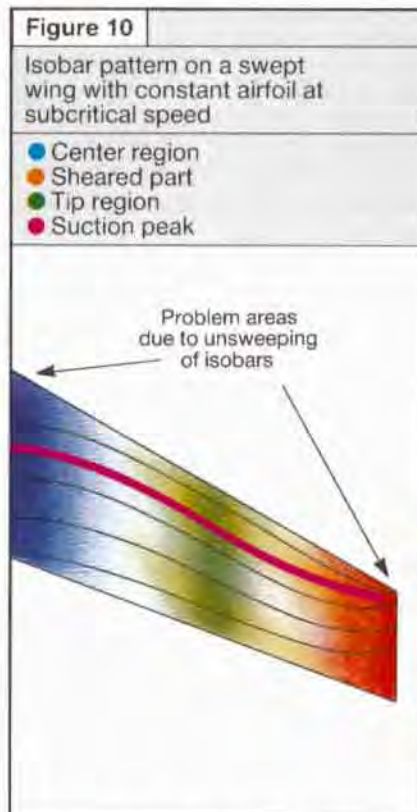

This leads to a simple and rather obvious general criterion: it is beneficial to design swept wings to have as far as possible straight and fully-swept isobars all along the span, right into the center, as indicated in Figure 11. Loss of isobar sweep results in an unnecessarily low drag-rise Mach No. Even with the heavily cranked trailing edge of the A310 wing, BAe have been successful in maintaining a near constant sweep of the isobars. The complication of the crank resulted from the requirement to offer sufficient space and depth to stow the landing gear behind the main wing box and to provide more fuel tank volume.

An example of what was achieved is shown for a wind tunnel test in Figure 12. Here under conditions of high lift buffet onset at a long range cruise Mach No., a uniformly swept shock has formed at the back of the super

critical zone, indicated by the bunching together of the isobars, with a hint of the formation of the traditional  $\lambda$  shaped double shock system towards the root, Figure 14.

Optimization of the wing to get the swept-back straight isobars, (always hampered by the detrimental interference of fuselage and engine nacelle), is achieved by reshaping the inner wing, giving its airfoils more thickness forward, changing the distribution of the airfoil mean-line curvature or camber and twisting them relative to each other. The

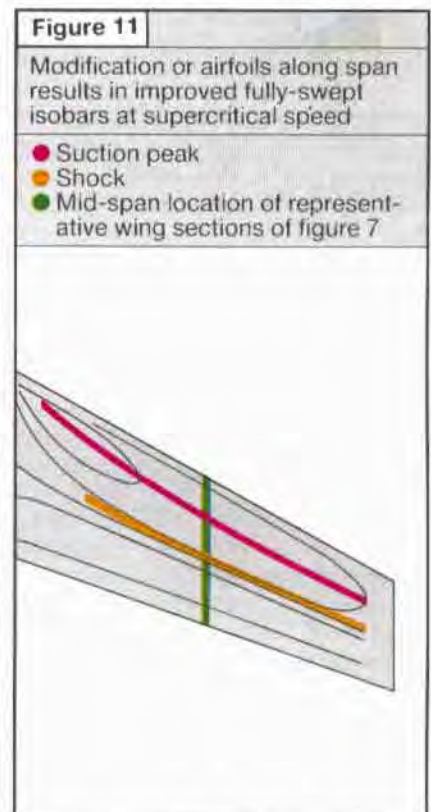

middle part of the half-wing is only slightly affected by the 3D effects and therefore the original 2D airfoil is used there.

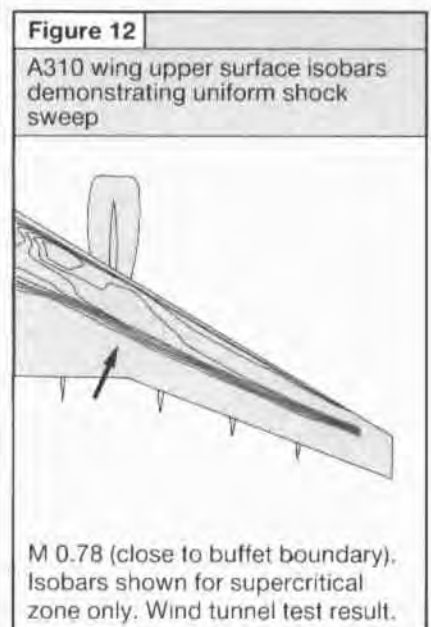
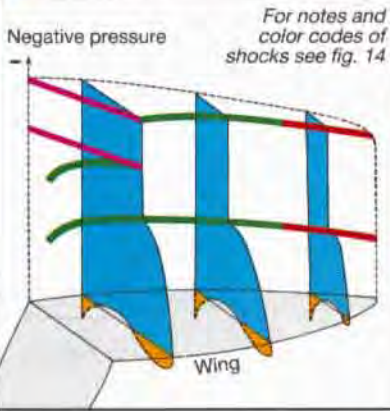



**Figure 13**

Simple model of pressure distributions over swept wing with supercritical flow

- Negative pressure
- Positive pressure



For the connoisseur of pictorial aerodynamics (Figure 14) sketches a pressure distribution of flow past a supercritical wing, as it is looked at by the aerodynamicist when developing computational methods. Figure 14 explains the underlying shock pattern, as it would present itself

**Figure 14**

Possible basic shock wave pattern on a supercritical swept wing

- Oblique shock wave
- Shock wave unswept because of symmetry
- Shock wave unsweeping towards wing tip

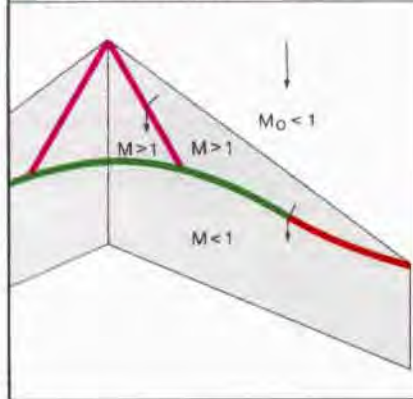

before comprehensive inner wing treatment. Let us now have a look at the advance achieved for the A310 wing: Figure 15 confirms the increase in wing thickness across the span, but especially at the

**Figure 15**

A310/300 technology comparison

- A310
- A300

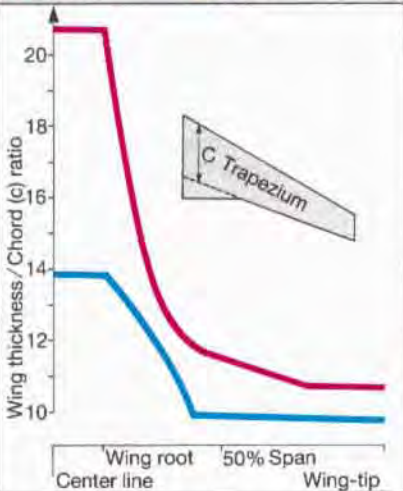
**Figure 16**

Lift coefficient boundary

- A310
- A300

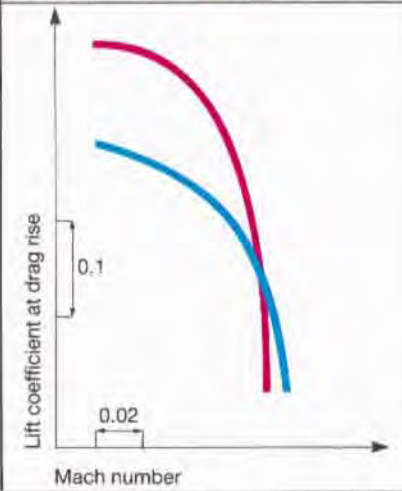
**Figure 17**

Advance in high speed wing design/in service data

Aerodynamic advance expressed as equivalent mean thickness/chord ratio ( $t/c$ ) increase.

Fixed : Sweep, Mach number, Cruise lift Coefficient.

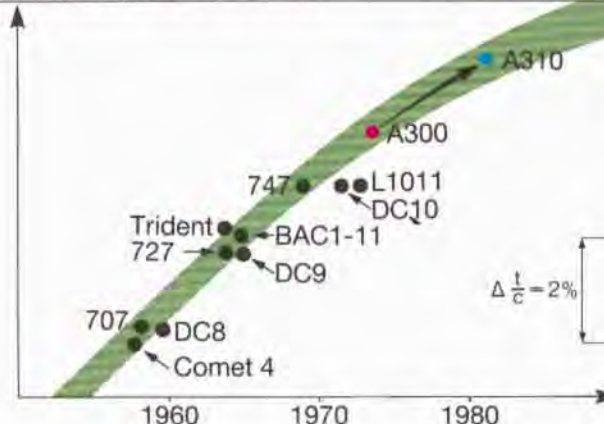

inner end, where it has most effect on wing weight and fuel volume. Figure 17 puts the A310 in relation to previous designs. Comparing the lift/Mach No. boundaries (on-set of buffeting), for the A300 and the A310 (Figure 16), we see that the substantially thicker A310 wing carries considerably more lift at the expense of a slight loss in Mach No. capability at lower lift coefficients. This drag rise boundary is particularly important for a transport aircraft as it virtually defines the limit of operating conditions.

In Figure 18 we find the result of all these efforts, a rather fat looking wing section at the root.

### WIND TUNNEL VERSUS COMPUTATIONAL AERODYNAMICS

When, through the development of the "Wing Theory" for 2D flow around an infinite wing of constant section (Figure 3), and for 3D flow around a complete wing, mainly by Frederick W. Lanchester (1878-1946) and Ludwig Prandtl between 1907 and 1918, the problem of lift finally became accessible to mathematical treatment and the designer could be given important information about the influence of such geometrical features of a wing as aspect ratio, chord, twist distribution etc. Still for a long time the complexity of the mathematical calculations involved in determining lift could be very impressive. Therefore aerodynamic research and design had to keep on blending theory and experiment, the latter characterised by the extensive use of model testing in wind tunnels (really an analog computer for integrating the complicated equations of lift), alongside the ideal but very expensive flight testing. The growing complication and broadened performance envelope of aircraft brought a progressively increasing demand for wind tunnel testing; less than 100 wind tunnel hours were necessary for DC3, the DC7 needed 2000, the DC8 over 10,000 and the 747 around 14,000 hours. This trend means that by now a major new aerospace design would require 2 tunnels working around the clock for over five years, and this at a power demand for one very large tunnel of between 100,000 and 200,000 horsepower! No wonder that the escalating wind tunnel test costs and energy requirements have provided a consider-

rable incentive for the development of the computational techniques.

Since the early seventies the growth in computer capability, a parallel decline in relative computational costs and the rapid advances in the development of theoretical methods in aerodynamics, have brought about a profound change in the role of experiment and computation. Already now numerical methods can be more cost effective than wind tunnels and offer more accuracy than the tunnels with their wall interference problems and model support interference problems and the limitation in the size of the models that can be placed in them. NASA has a whole list of various shortcomings in predicted transonic performance and drag for transport and military aircraft due to problems with wind tunnel testing that could have been avoided using today's computational techniques.

Boeing feels that it now has the ability to do approximately 80% of a transport's wing final design by computational methods, with the wind tunnel mainly used for verification.

The A310 wing is a good example of current achievements in computational aerodynamics. It was designed using computer programs developed in England. The use of these programs was responsible for a major advance in aerodynamic standard which would have been very difficult and time consuming to accomplish with the mix of experimental and approximate computational methods available at the time of the A300 design. As it turned out the reduced wind tunnel program had very little impact on the wing design process in achieving this advance. The elapsed time between start of theoretical wing design and geometry freeze was reduced from 3 to 2 years, but total costs stayed about the same, as computing costs balanced the reduction in experimental costs. The wind tunnel program continued to play an important role as an "insurance", to get an early check on the buffet boundary and to help solve interference problems at the root/fuselage junction, the engine installation and at the flap-track fairings.

The revolution in computational methods for predicting pressure distributions has enabled the A310 design to be carried out almost wholly theoretically, allowing more time and effort in

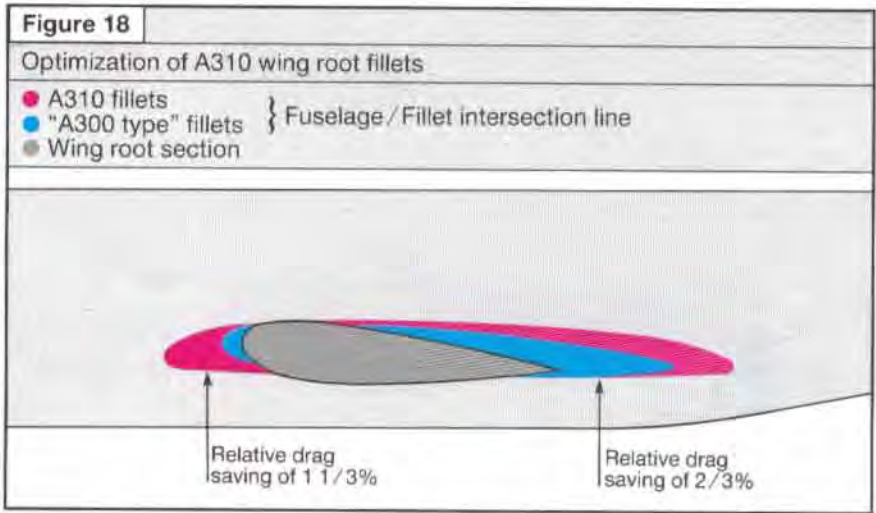

the wind tunnel program to be directed towards important interference effects between the wing and other components of the aircraft.

Looking at the root/fuselage junction first, the rear of the wing chord has always been, without suitable filleting, a region where separated flow is likely to occur. The very large increase in thickness/chord ratio of the root section on the A310 led to the expected worsening of the separation problem, with the result that the wing root trailing edge fillet has been increased in size giving the savings in cruise drag shown in Figure 18. There is also flow separation at the wing root leading edge; the fuselage bound-

ary layer approaching the wing cannot traverse the adverse pressure gradient close to the leading edge stagnation zone without separating and rolling into a vortex. Another fillet, with the high-lift Krüger flap designed into it, fully suppresses this vortex.

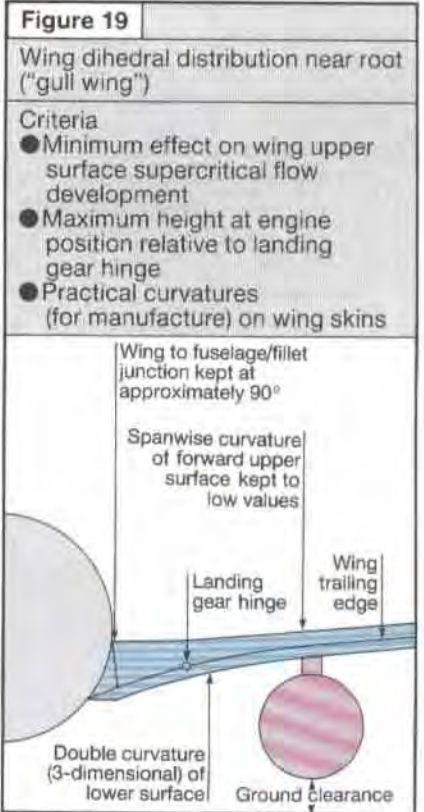
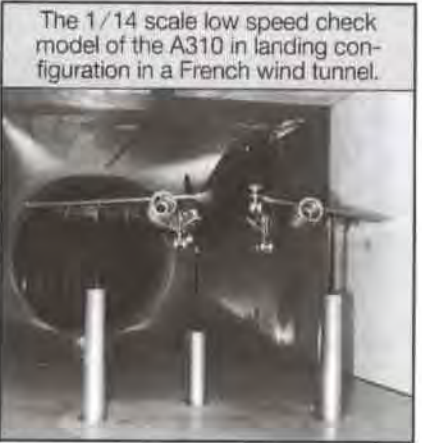

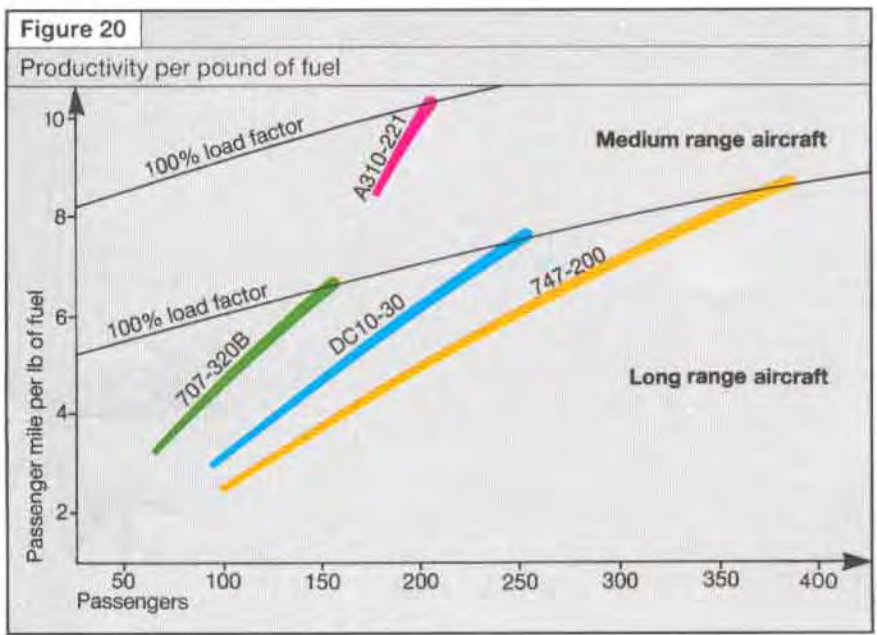

The wing carries the engine installation which can also produce interference drag that needs to be dealt with, e.g. high flow velocities in the "channel" between the wing lower surface, the

pylon side and the nacelle upper surface. Providing adequate clearance between the large fan engine and the ground whilst reducing the main landing gear leg length

to a minimum, for weight and cost saving, led to the pronounced "gull wing" effect shown in Figure 19.

The high-lift devices were basically taken over from the A300, where they had proven very effective, but the slats were given bigger chord and radius to improve take-off performance and the two outboard flaps of the A300 were joined to make one flap on the A310, supported now on only three tracks. In the general cleaning up of the wing (getting rid of steps and leak paths), the flaps were simplified and the tracks on which they run required improved fairings.

As in so many technical advances, there are some negative aspects to the supercritical wing. The increased lifting capability of the wing with its "rearloaded" airfoil (Figure 7), leads to a large nose-down pitching moment, which must be balanced by a tailplane



down load to trim the aircraft about its center of gravity. The tail-down load together with the additional wing lift required, which partly offsets the basic lift improvement being sought, causes a small but measurable drag penalty called trim drag. This interference between wing and tailplane had to be optimised by looking at them together. This included increasing lift inboard relative to an optimum isolated wing, which on a swept wing gives a nose-up pitching moment reducing the tail down-load. Concentrating the lift inboard also improves the structural efficiency of the wing; yet another trade-off!

Without thinking in detail about the production techniques required one realizes that building the double-curvature wing skins of the inboard bottom part of the A310 wing with its impressive thickness tapering from root to tip is a great achieve-



The first A310-300 wing arriving in Toulouse by Airbus Industrie Supper Guppy

ment in itself. Both the flight test program and later in-service experience proved that the A310 met and even exceeded its performance targets quite handsomely, not least thanks to its

wing design. Figure 20 underlines the standards reached by the A310 and demonstrates what a mighty tool a wing is, being able to produce over 20 times more lift than its own weight.



# FUEL CONSERVATION PART 5

*By a team of Airbus specialists from  
the Technical Department, the Flight Test  
Operations Department, the Support Division,  
the Technical Publications Department  
and Engine Manufacturers.*



**“What goes up must come down !”**

Such are the laws of gravity, and this rather time-worn truism still holds good, especially in the world of aviation. However although coming down may, at first sight, appear easier than going up, a lot can depend on how you come down : a lot of precious fuel may be wasted by not observing some relatively simple procedures. This article, the last in the Fuel Conservation series, deals with economies that can be achieved during the holding, descent and landing phase of the flight.

## HOLDING

When engaged in a hold pattern the same general rules of "clean configuration=economical flight" apply. The extension of flight control surfaces causes fuel-thirsty drag. Holding for 15 minutes at 120 tonnes and at 5,000 ft costs 300 kg (approx. 100 US gallons) more fuel when performed at 210 kt with slats extended than when performed in a clean configuration at minimum drag speed (Figure 1).



**Figure 1**

● Slat/flaps 16°/0°/ 210 kt      ● Slat/flaps 16°/0°/ 170 kt      ● Clean configuration minimum drag

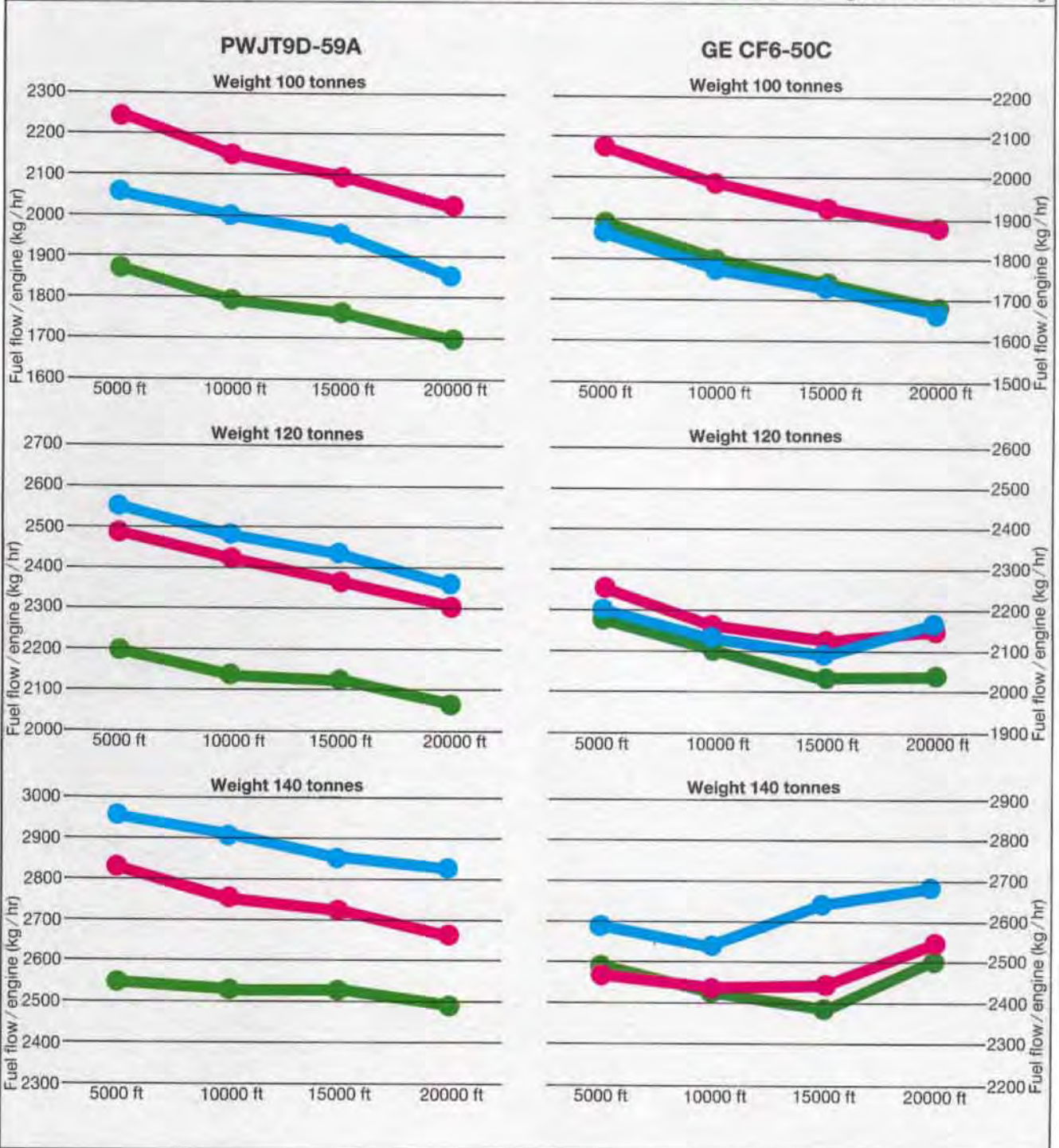



## DESCENT

Whatever the flight conditions the optimum descent speed is about 280 kt, however a speed limit of 250 kt below 10,000 ft has been used in the calculations of Figure 2 to cater for normal Air Traffic Control (ATC) constraints.

Figure 2 shows the fuel consumption during descent from the same point in cruise to 1,500 ft for different aircraft weights and flight levels and for different ambient temperatures.

From FL 310 at ISA, descent at M.78/280 kt/250 kt would consume approximately 360 kg of fuel compared with over 380 kg at M.78/300 kt/250 kt. This 20 kt reduction in descent speed would save about 5,000 US gallons per year. The savings are greatest at low aircraft weights and low ambient temperatures.

Figure 2

Descent

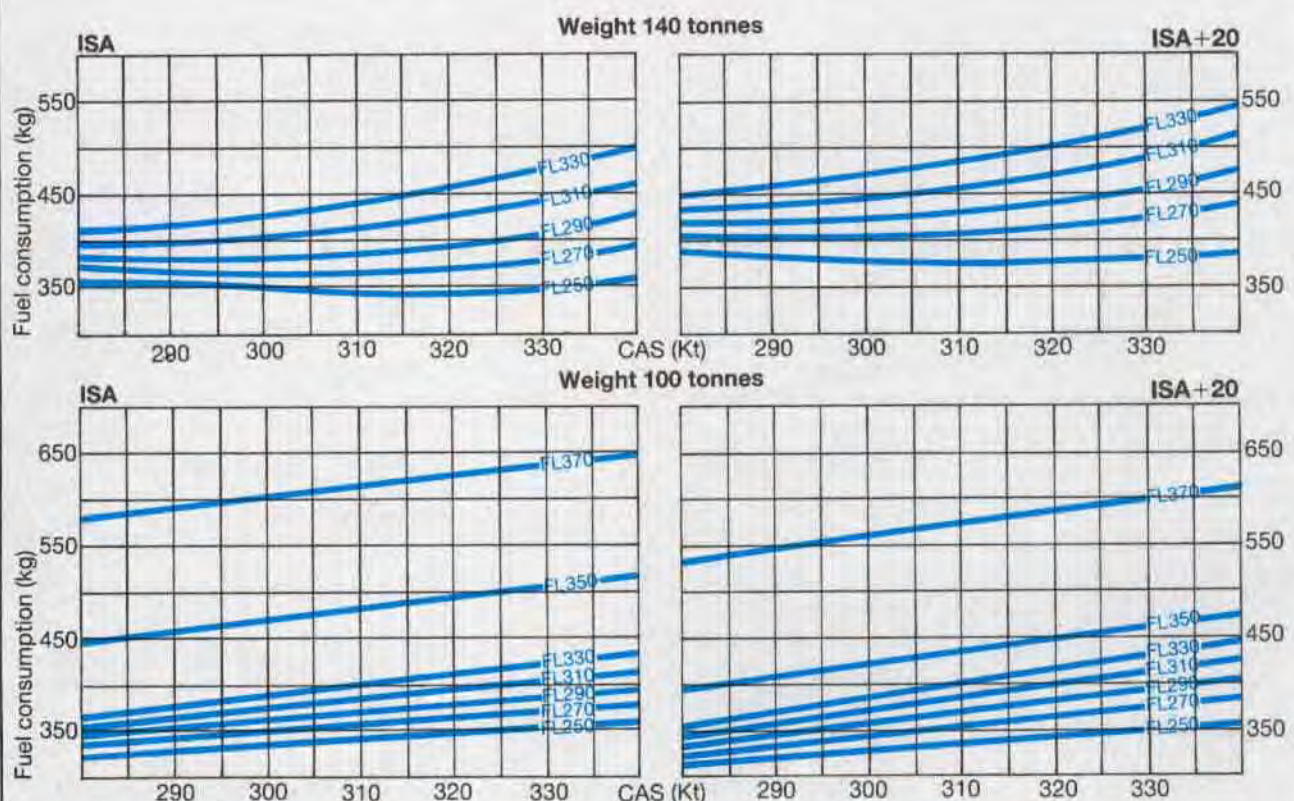

## DECELERATED APPROACH

The use of a decelerated approach as shown in Figure 3, gives better compatibility with ATC constraints, (keep high speed as long as possible) means a decrease in aircraft noise during approach and saves fuel and time.

This procedure, which can only be used in category 1 or better weather conditions, consists of extending flaps, slats and landing gears as late as possible in the approach to minimize drag and thus reduce fuel consumption. The fuel savings is approximately 150 kg per approach which could mean an annual savings of 68,000 US gallons per aircraft per year (1.62 hr sector / 2,239 fh per year).

## LANDING

The greatest savings at this stage can be gained through avoiding completely the use of reverse thrust at low aircraft ground speeds. These operations put the engines through an additional life cycle and increase the possibilities of damage and compressor blade erosion, particularly on contaminated runways due to ingestion of hot gasses, sand and other foreign objects, all contributing factors to deterioration of engine performance.

## TAXIING

Taxiing on two engines consumes fuel at approximately 30 kg/min. However taxiing on one engine although requiring double the thrust on the single engine does not result in double the fuel burn of that engine. A saving of approximately 9 kg/3 US gallons per minute can be realized for that portion of the taxi-in performed on one engine.



Figure 3

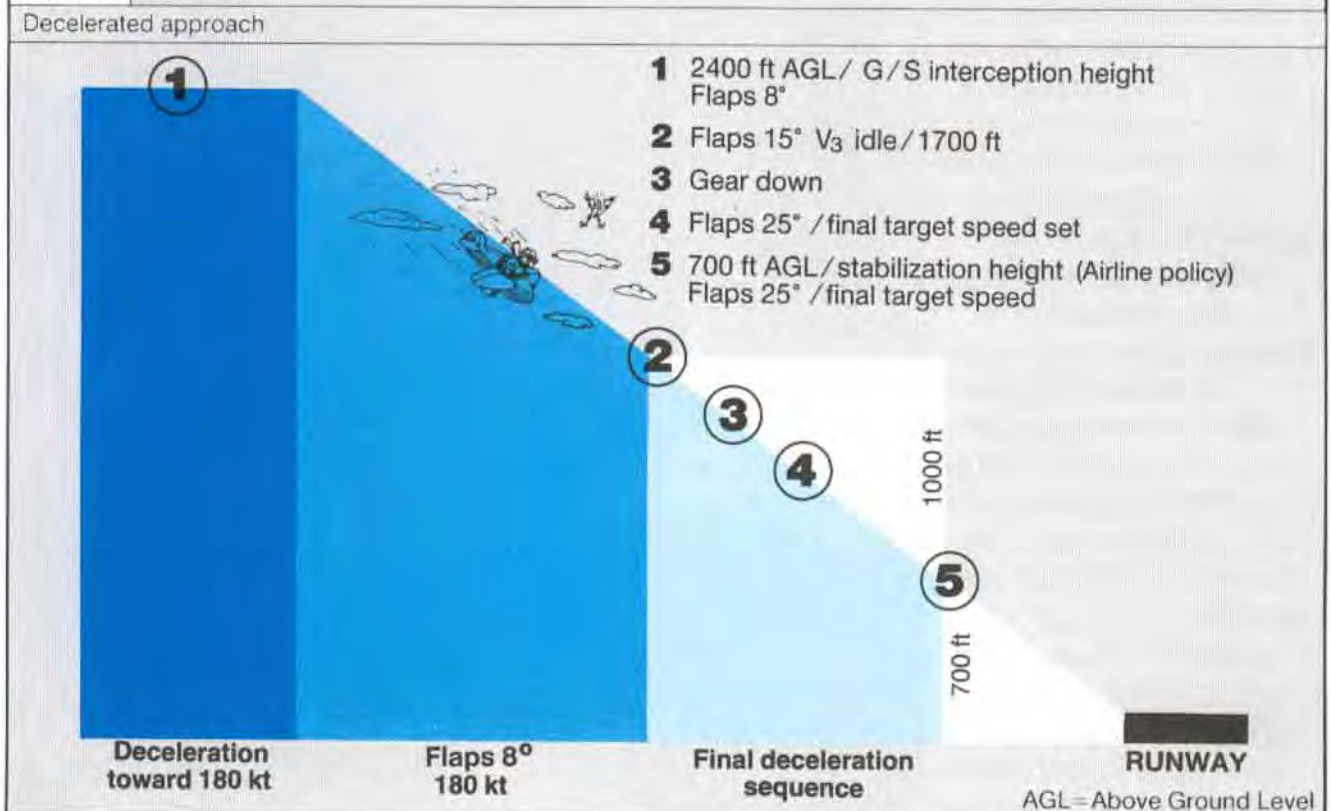

## CONCLUSION

This concludes the series of articles on fuel conservation in A300 fleets. However, since the subject is always a topical one and of interest to all operators, the information flow does not necessarily stop at this point. If any of the airlines are using specific procedures in operations and maintenance practise which show even greater economies than those discussed in the foregoing article, FAST will be pleased to publish any such information for the benefit of all Airbus customers.

Airbus will shortly be publishing the complete series of Fuel Conservation articles in a single volume.





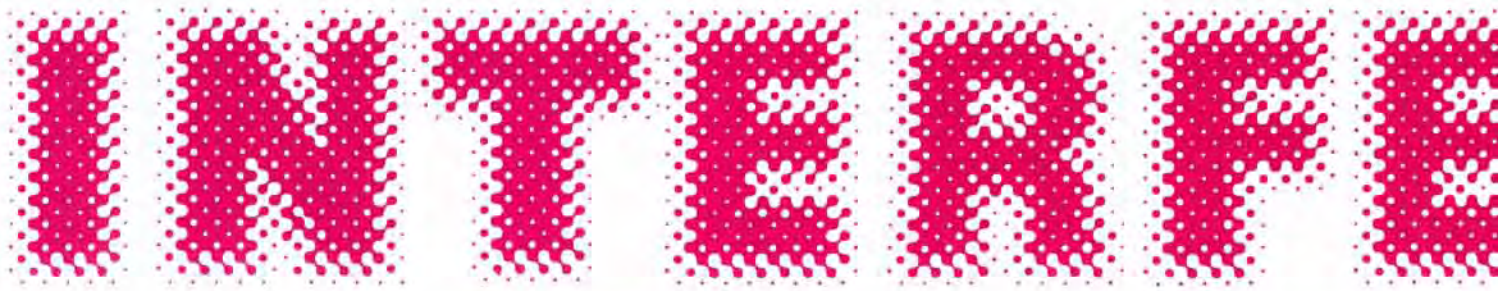

Alain Lopicard  
Engineering Support Group 1  
Aérospatiale

What could be less dangerous than a simple game of chess, backgammon or even Star Wars? However, if the games in question are electronic gadgets and you happen to be playing them in an aircraft, then the consequences might be more serious than you think.

*'Warning from Great Britain. Simple electronic games upset aircraft navigation system !'*

Such was the dramatic title of an article in a well-known French newspaper concerning the story of a British registered aircraft which had reportedly drifted more than 70 nm off-course because a passenger was using one of these simple electronic games. In view of this sort of problem, airlines are now asking themselves whether or not it is prudent to allow the use of these kinds of games on board their aircraft as well as calculators, tape recorders and transistor radios.





The urgency to resolve this question grows as the use of these articles becomes more and more widespread. An example of how the problem grows can be seen in the following letter published in 'Aviation Week and Space Technology', 5 November 1984 :  
*'CRT in the Cabin. I am an airline pilot and recently, while established at cruise on a domestic flight, encountered a situation new to me. For no apparent reason a number of electrical relays in the cockpit tripped on and off. We could determine no cause for the apparent faults. Shortly after, though, the purser came onto the flight deck to report that a passenger was operating a battery-powered personal computer, complete with CRT unit, in his seat. We directed the passenger to turn it off and the relay interruptions ceased. The potential hazard is not new and speaks for itself, but was any passenger on KAL 007 operating a portable computer ? It would be a remarkable coincidence.'*

**Figure 1**

**Spectrum analysis**

- Limits with biconical antenna (20 mhz to 200 mhz)
- Limits with log spiraled antenna (200 mhz to 1 ghz)
- Spectrum

**Super-8 Cine-Camera**

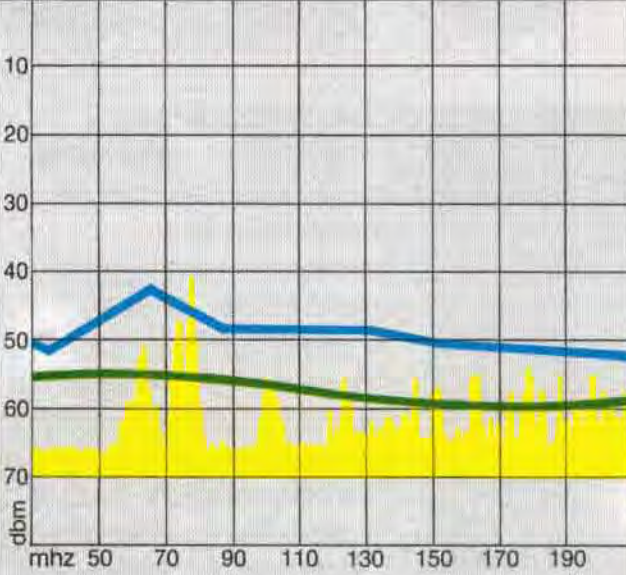

**Electric shaver**



**Walkie-Talkie**

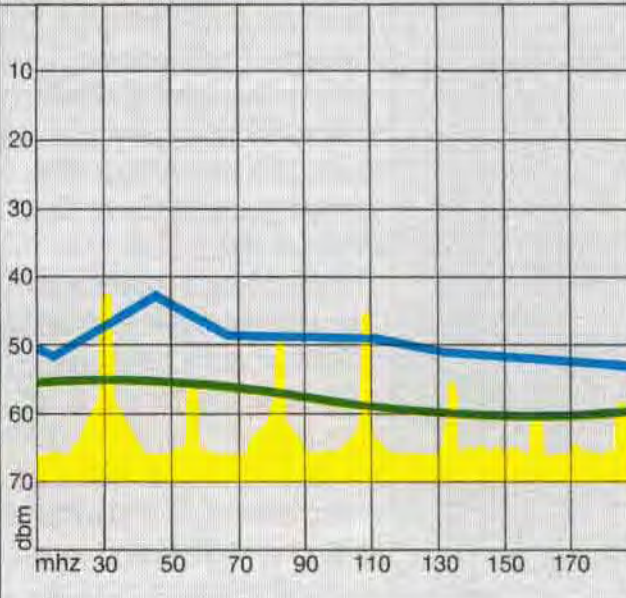

Surely such alarming prospects have not gone unnoticed by the authorities? What are their attitudes to such dangers? The FAA has the following words in FAR 91-19:

'(a) Except as provided in paragraph (b) of this section no person may operate, nor may any operator or pilot in command of an aircraft allow the operation of any portable electronic device on any of the following US registered civil aircraft:

(1) aircraft operated by an air carrier or commercial operator, or

(2) any other aircraft while it is operated under IFR.

(b) Paragraph (a) of this section does not apply to:

(1) portable voice recorders,

(2) hearing aids,

(3) heart pacemakers,

(4) electric shavers, or

(5) any other portable electronic device that the operator of the aircraft has determined will not cause interference with the navigation or communication system of the aircraft on which it is to be used.

(c) In the case of an aircraft operated by an air carrier or commercial operator, the determination required by paragraph (b) (5) of this section shall be made by the air carrier or commercial operator of the aircraft on which the particular device is to be used. In the case of other aircraft, the determination may be made by the pilot in command or other operator of the aircraft.'

In fact according to paragraph (b) (5) the FAA leaves the responsibility to the airline to decide which other equipment may or may not be used. They also state, in Amendment 91-35, that testing of every conceivable electronic device likely to be carried on board an aircraft would place an excessive and unnecessary burden on the Agency and they therefore require the 'air carrier or commercial operator to determine whether a particular portable electronic device will cause interference aboard its aircraft.'

The CAA states the following in Aeronautical Information Circular No. 44.1982:

'Radio interference of a level sufficient to interfere with sensitive aircraft equipment several feet away is known to be generated by such equipment as calculators and electronic games with light-emitting displays. However, watches and calculators which use liquid crystal displays and other low power consumption equipment such as heart pacemakers generate negligible interference. In large aircraft the separation of passengers from sensitive aircraft equipment is usually sufficient to avoid interference but in small aircraft, on flight decks and where equipment is in use which produces exceptional levels of interference some aircraft equipment may be affected.'

In the Airbus A310 the items most likely to be affected are those shown in the diagram below.

In order to construct some sort of data base and allow a more formal approach to the problem, a

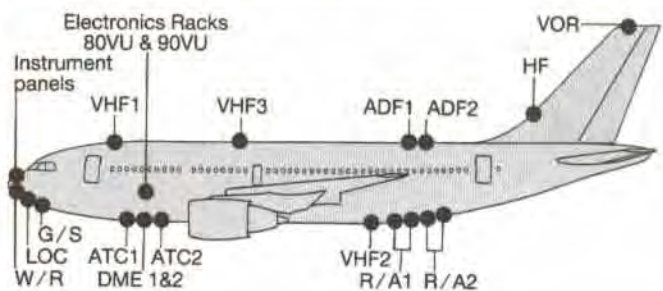

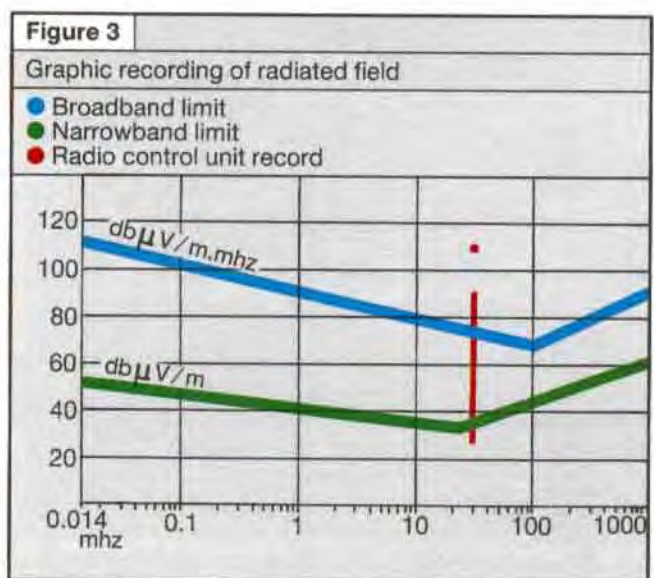
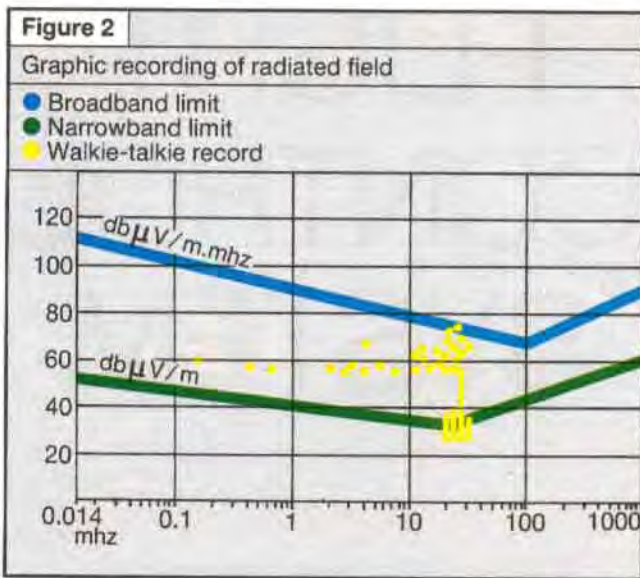

series of tests was undertaken by Airbus Industrie upon a number of electronic games and devices to determine their spectrum of emission. Although intended as a general guide, it would be unwise, however, to extrapolate the results to give a general theory covering all eventualities.

The articles tested were a radio control unit, a walkie-talkie, a super-8 cine-camera, a portable video unit, a 'Walkman' cassette player, an electric razor, an LED display calculator, a number of electronic games, Star Wars, etc...

The testing was undertaken in two phases. Phase 1 consisted of a rapid verification of the electronic signatures, undertaken by spectrum analysis, in order to determine which objects were liable to emit electrical interference.

**Phase 1 results**

Equipment with significant electrical signature	Equipment without significant electrical signature
Radio control unit Walkie-talkie Super-8 cine-camera Portable video unit Walkman radio Electric razor	Walkman cassette player LED / LCD calculators Electronic games

Since these "domestic" items do not have to meet rigorous aviation standards, not surprisingly some

of them exceed the emission limits. Figure 1 illustrates the three most significant 'signatures', those of the super-8 cine-camera, the electric razor and the walkie-talkie. Electronic calculators and games emit no significant interference, which is not really surprising considering their very small power requirement.

Phase 2 consisted of a much finer analysis using a frequency scanning receiver with a graphic recorder. The tests were undertaken in accordance with RTCA DO 160/EUROCAE ED 14 (Radio Technical Commission for Aeronautics/European Organization for Civil Aviation Electronics) recommendations which provide the emission limits for electronic components used in aircraft.

**Phase 2 Results**

Considering only those items giving out a significant electrical interference emission, Figures 2 and 3 illustrate the more serious conditions. Overall results are shown in Figure 4. Phase 2 testing revealed that some things such as walkie-talkie and radio controlled toys were well over the RTCA DO 160 imposed limits and encroached upon HF radio frequencies. In fact, as a precaution, some airlines already forbid the use of such toys on board the aircraft, but the other article tested also proved to be outside the norm. RTCA DO 160

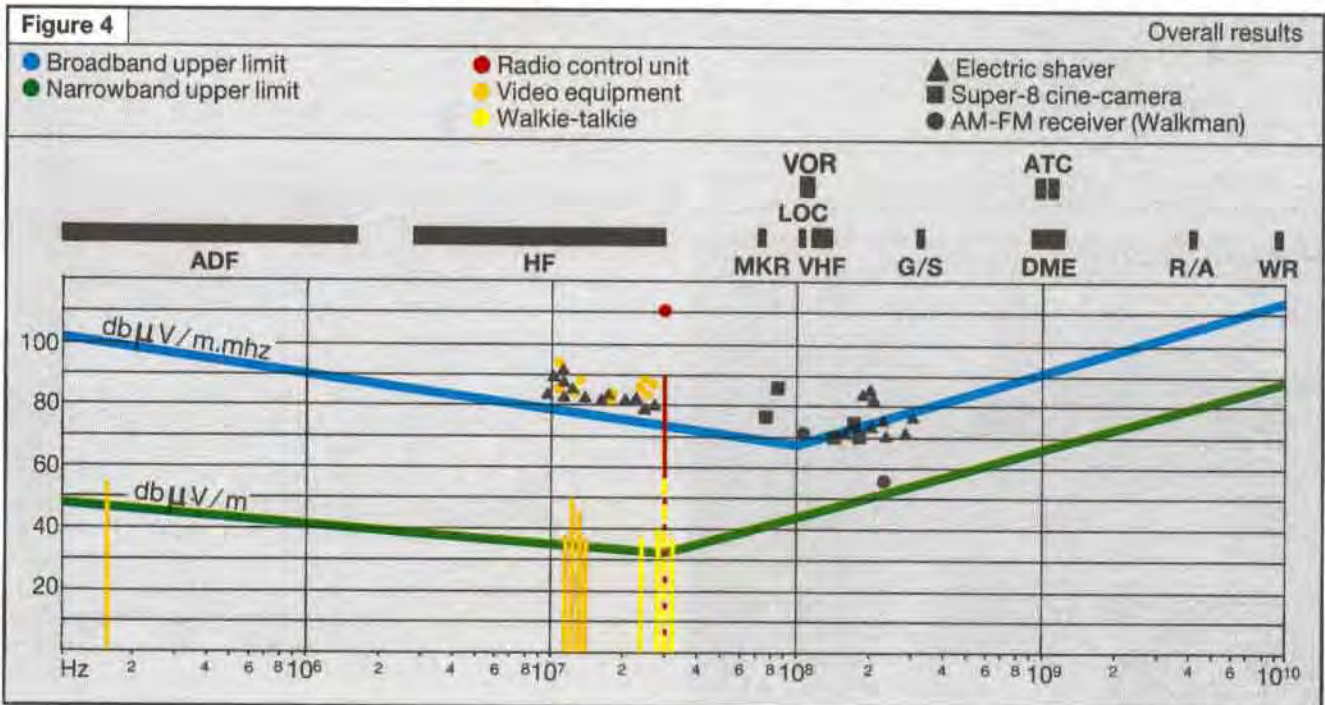

regulations control the permitted level of interference emissions relative to aeronautical electronic equipment, and as such impose stringent test procedures upon all equipment.

Once installed in the racks, equipment complying with the norm must show no tendency whatsoever to interfere with adjacent equipment. Although the 'domestic' equipment tested were not designed to aeronautical specifications, unless they are positioned very close to on-board computers, antenna or non-insulated cables, it is very unlikely that they would cause serious interference.

In the near future Airbus Industrie will test a battery powered portable computer on board its aircraft. The results of these tests will be published in the following issue of Fast.

But what about the case cited at the beginning of this article? What actually happened? In fact the aircraft did not really deviate 70 nm from its course, but the instruments did give an erratic reading varying from 70 nm to 90 nm. The culprit was not an electronic game but a walkman operating close to one of the aforementioned critical zones, probably an antenna. Simply asking the passenger to sit elsewhere would certainly be sufficient to stop such interference-if the cause of the problem is recognized!

In order to demonstrate the unlikely nature of such phenomena the equipment tested in Phase 2 was taken into the cockpit of an A310 static simulator in a laboratory and turned on. No interference of any sort was recorded on the flight deck instruments. The experiment was repeated in a simulated A310 electronics bay, again with no detectable interference. However, one airline had an interesting experience during a maintenance check on an aircraft of another manufacturer. A portable walkie-talkie being used inside the aircraft caused the closure of the outflow valves in the cabin pressure system. The walkie-talkie was on a frequency of 465 mhz with a power output of 2 to 5 watts. From the above information and the results of the tests it would therefore seem advisable to prevent the use of radio wave emitting toys or equipment in the aircraft during flight as is stated in FAR 91-19 paragraph (a).

These tests were not intended to record all forms of possible electrical interference but simply to open up an area of potential hazards and perhaps provoke further research. It also enables the airlines to direct their own investigations, as required, so as to enable them to comply with and understand the spirit of FAR 91-19.

The Technical Editor of Fast would welcome correspondence on this subject, to be published, unless otherwise requested, in subsequent issues.



# FLIGHT CONTROL SYSTEM



Bernard Ziegler  
Flight Test Pilot  
Senior Vice President  
Flight & Support Directorate  
Airbus Industrie



Michel Durandea  
Flying Control Design  
Engineer  
Design Office  
Aérospatiale

**For the majority of large civil aircraft flying today, control surface positioning is achieved by mechanically controlled hydraulically powered servojacks. To face current requirements in aircraft performance and flight envelope, with consideration for aircraft size speed and performance, high Mach No. operation, ATC density and crew interface, such systems have had to be highly sophisticated.**

As an example, a standard pitch control includes (Figure 1):

- a variable artificial feel system to modulate pilot forces as a function of flight condition,
- a servoed autopilot input,
- high lift protection devices like stick shaker and stick pusher,
- stability augmentation systems such as Mach, speed and/or angle of attack trim,
- a control wheel steering input to the autopilot from force detectors,

a dual path splitting system for jamming protection. Step-by-step were added: jacks, screw jacks, dynamometric rods, bell cranks, differential position transmitters and microswitches, to a point where a very heavy and expensive system is a maintenance nightmare and does not offer any real flexibility for future developments to engineering. The result was over-complexity which hampered further improvement in weight and fuel saving. Such a log-jam situation has naturally driven the design engineers to completely reconsider the situation and to move to a new concept 'Fly-by-Wire' (FbW) which requires only a digital computer data bus and electro-hydraulic servo's. Within Aérospatiale, a partner of Airbus, the development of this new concept started 20 years ago.

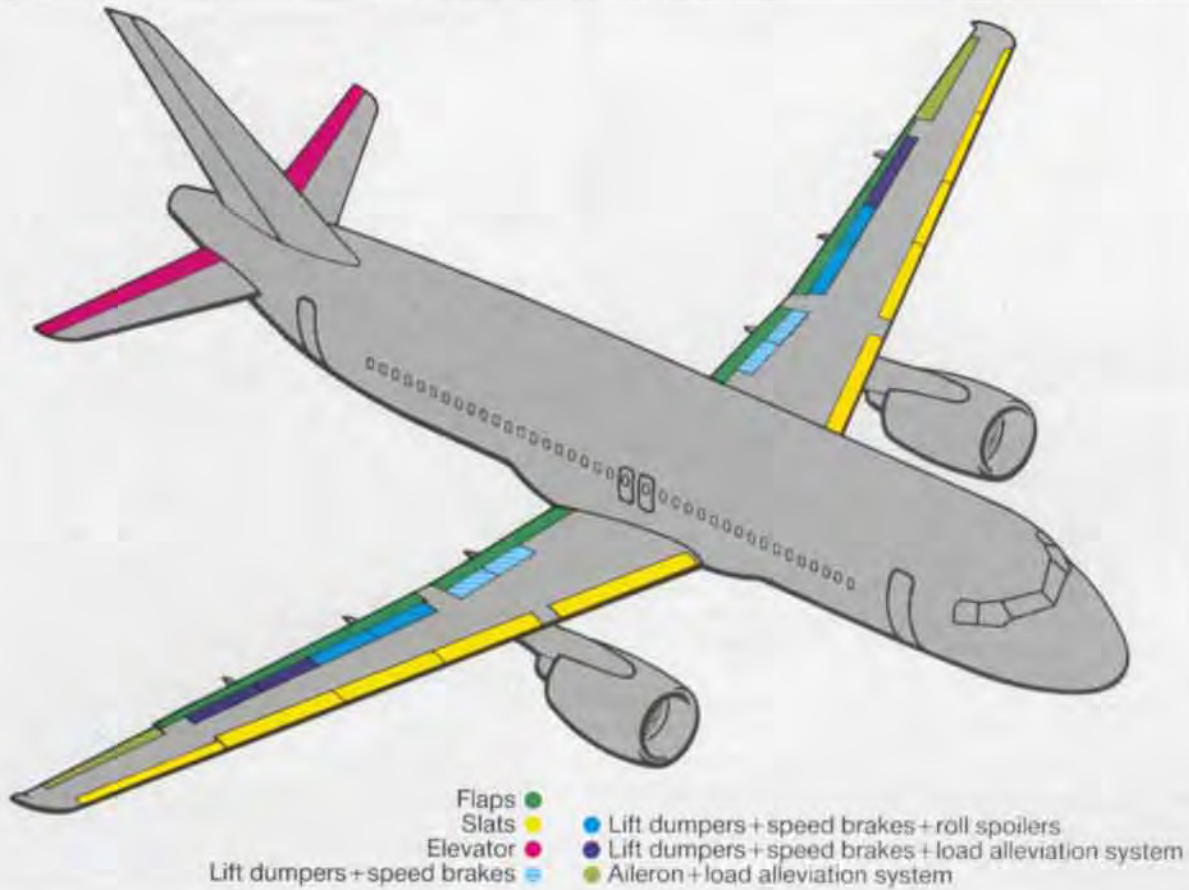

**FIRST STEPS IN ELECTRICALLY SIGNALLED FLYING CONTROLS.**

The first application for civil aircraft was achieved to face the extension of the flight envelope with SST Concorde, with has been flying since 1969 with full authority electrical control on the three axes. The technology available at that time (analog computer) and the lack of experience put a severe limitation on the system design : a mechanical back up was maintained, (never used to our knowledge in revenue flight), and in this degraded mode supersonic flight is no longer permitted.

Another significant step has been achieved with the A300-600 and A310 upper wing control surfaces where there is no longer any mechanical back-up. In this case the Fly-by-Wire concept has proven to be extremely efficient. With the same wing, (A300B4/A300-600), a weight saving of 300 kg

was achieved plus some drastic simplification such as the suppression of the low speed aileron. Roll control quality and efficiency were nevertheless improved (Figure 3). Based on this experience it was reasonably obvious that the new technology was sufficiently mature and allowed weight saving and other targets to be set, such as protection improvement at the limit of the flight envelope, incorporation of a load alleviation system, build up of a new cockpit concept. Also, due to the novelty, some strong principles were laid down giving priority to maturing technology ; using it only where most efficient, and supporting it as far as possible with flight experiments.

The first experiments were conducted during the second part of 1983 on the A300 test aircraft SN003 which will partially be used for that purpose up to the end of 1985.

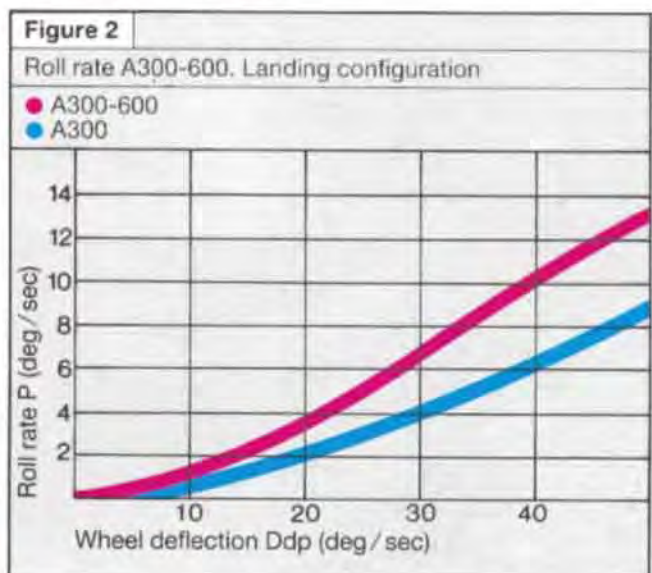
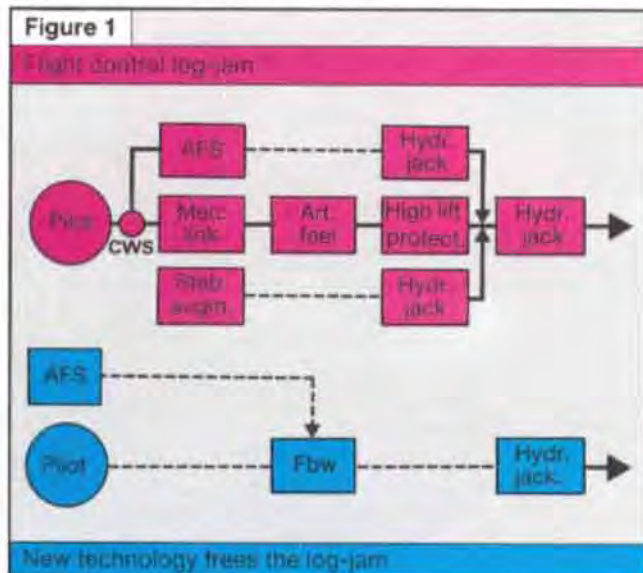

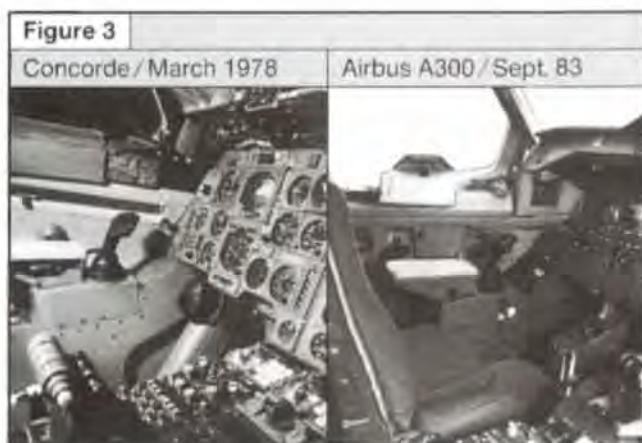

### ELECTRICAL FLYING CONTROL TESTS ACHIEVED ON AN A300

#### System definition

No change on the first officer's side; standard yaw control, electrical pitch and roll flight control from a side-stick installed on the Captain's console (Captain's control column and wheel were removed), electrical signalling through the autopilot (AFS) with a specific software.

#### Flight test activities

48 pilots from 5 airworthiness authorities, 12 airlines, 3 aviation magazines and Airbus Industrie had flown the aircraft for 75 hours in this configuration by the end of 1983. It is worth noting that before their first flight on the testbed aircraft, the pilots had a maximum of one hour flight simulator training on side-stick operations.

#### Main results

A qualitative assessment was made through a detailed questionnaire containing 42 questions filled in by each team of visiting aircrew - 25 such questionnaires were submitted, with the following results :

Rating	Unacceptable						Excellent
	1	2	3	4	5	6	
No of responses	17	34	92	204	352	317	
	1.6%	3.2%	8.8%	19.4%	33.8%	30.2%	

Unanswered questions, 34 or 3.2%. Total number of responses, 1050 taken from 25 questionnaires. Note that 25 of the 51 responses in 1&2 were related to roll characteristics.

The overall result was extremely positive and showed no difficulties of adaptation to side-stick, unanimous approval of pitch law, unanimous enthusiasm for the flight envelope protection especially at low speed, and an unexpected necessity to further develop lateral control.

An attempt at quantitative assessment was made

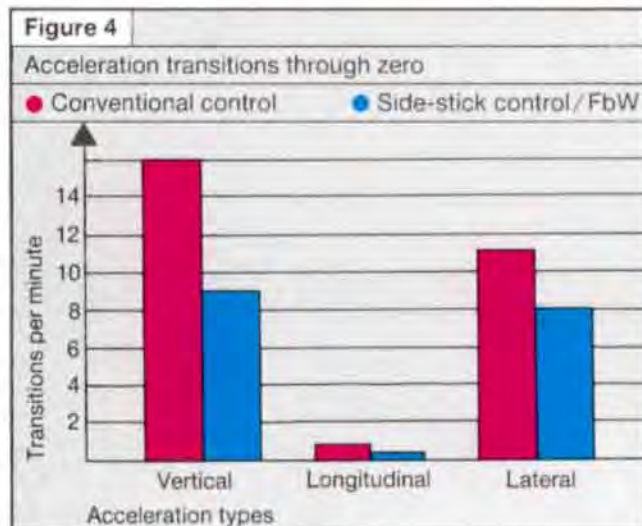

by manually flying twelve experimental circuits designed to pose a variety of flying problems. Three different combinations were used, they were flight director (FD) and auto throttle (AT) system 'on', ILS (FD and AT 'off') and NDB (FD, AT and ILS 'off'). These twelve circuits were flown twice by the same two pilots, once with conventional control, once with the side-stick/FbW system. The results of this experiment documented several major performance benefits of the side-stick/FbW system. All measurements of smoothness and stability favoured the FbW system. A typical example is the large reduction in transitions through zero of acceleration (Figure 4), more, the absolute of magnitude acceleration is significantly reduced, for example laterally from 0.004 g to 0.001 g.

The improvements in smoothness and stability noted above suggest that the aircraft/pilot system performs more efficiently when flown with side-stick/FbW control. This should yield reduced stress on the airframe and better fuel efficiency, which is confirmed by every recording of parameters related to drag fuel/burn.

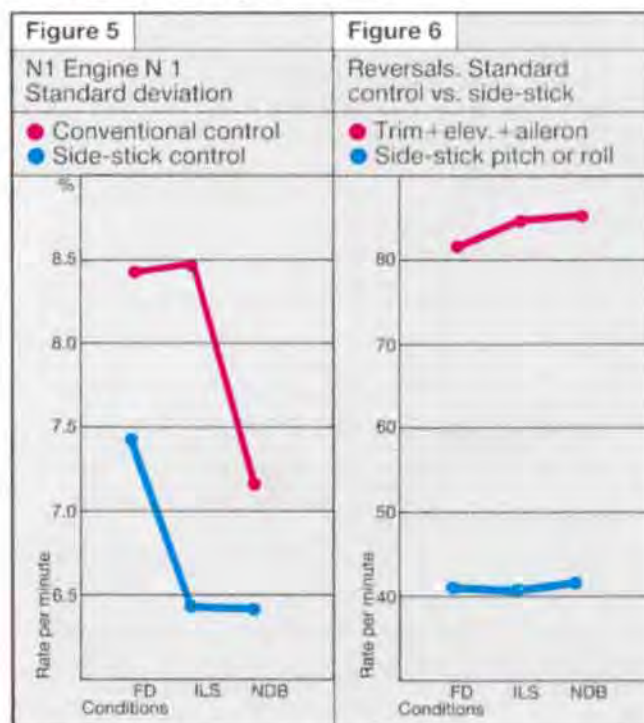

As an example, Figure 5 shows the standard deviation of the N1 engine parameter achieved in both cases. A startling reduction of pilot workload is also obvious (Figure 6).

### A320 ELECTRIC FLIGHT CONTROL SYSTEM (EFCS) ARCHITECTURE

**Safety objectives**  
The target was to be able to dispatch the aircraft with one EFCS computer failed while still meeting the following two safety objectives : complete loss of control, extremely improbable; any significant reduction of handling quality, remote.

The difficulty to factually demonstrate that a momentary loss of all control power is extremely improbable leads to the retention of a minimum mechanical back-up. Tests performed on A300 and A310 have shown that it was possible to keep a safe control in any configuration, over the whole flight envelope and in the whole range of CG by using only the rudder for yaw and roll and the trimable horizontal stabilizer (THS) for pitch. This leads to the following architecture :

a full EFCS will apply to roll and pitch control,

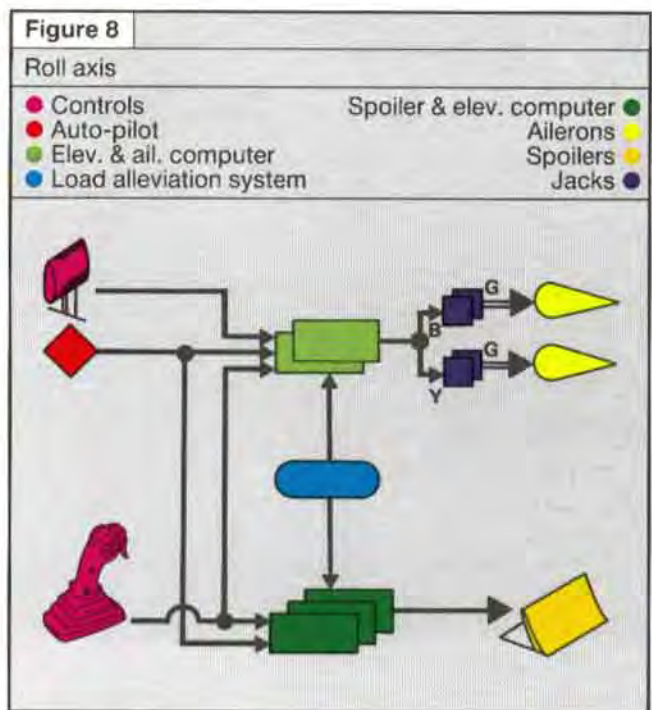
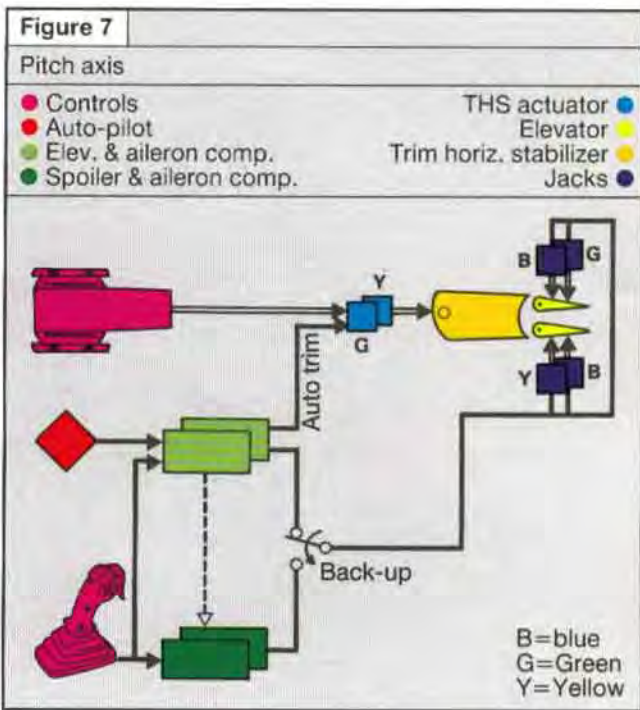

a minimum mechanical back-up will be ensured by a mechanically controlled rudder and standby THS.

**General architecture**

Pitch axis (Figure 7) : one THS and two elevators. Elevators are only electrically signalled, the THS is electrically signalled but incorporates a standby mechanical control.

Roll axis (Figure 8) : one aileron on each wing and four outer spoilers are all electrically signalled.

Yaw axis and ground steering : the rudder is mechanically controlled.

**EFCS architecture** (Figure 10)

Two types of computers ensure the electrical control : the elevator and aileron computer (ELAC) and the spoiler and elevator computer (SEC). Surface controls are powered by electrically signalled hydraulic servo jacks and associated with analog type position transducers (brushless inductive transducers in the unpressurized area), servo valves and solenoid valves. Normally one servo jack per surface ensures the active control, the other one being in damping mode. In case of dual failure both are switched to a centering mode (Figure 9).

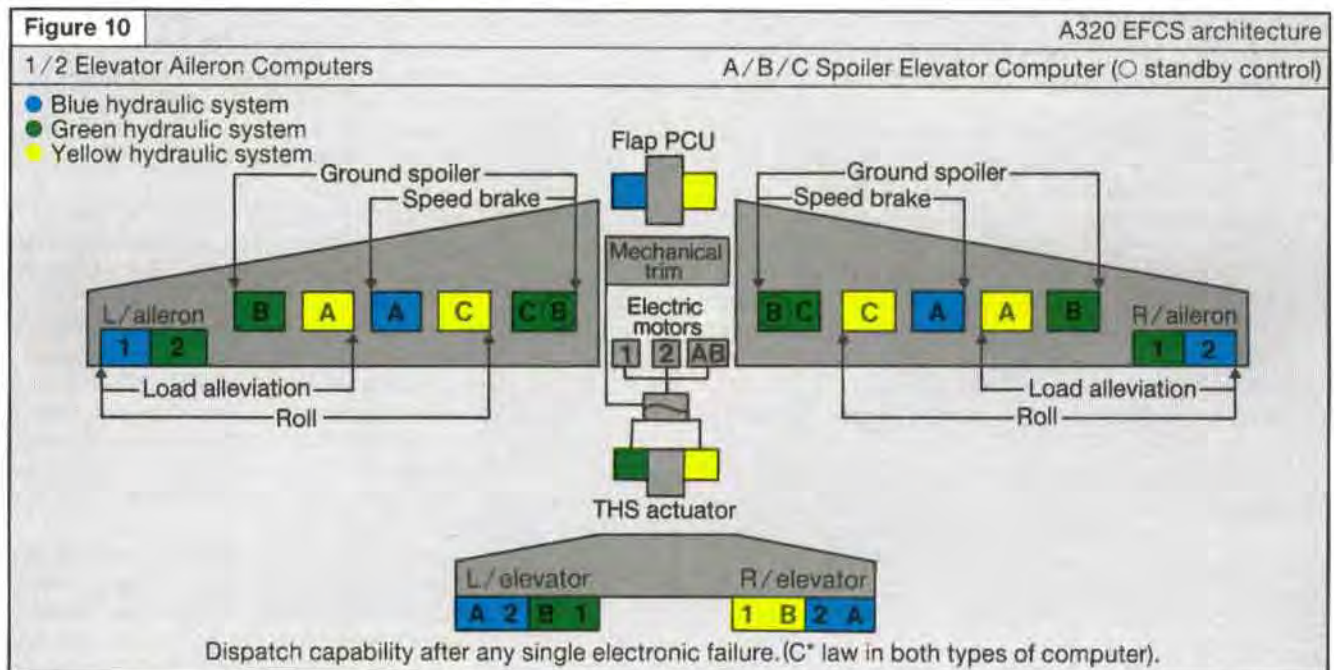
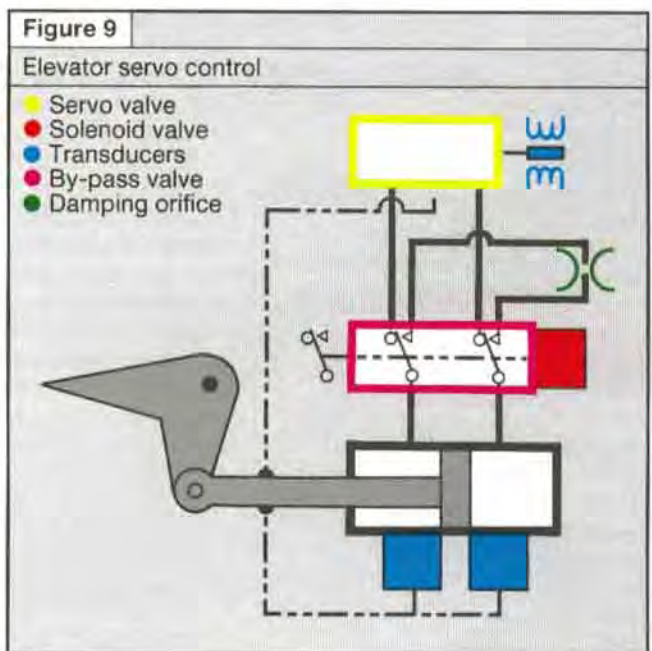

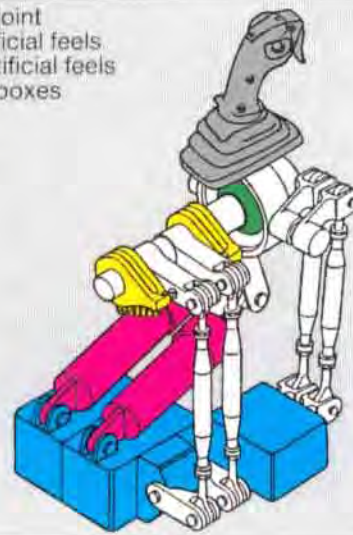

**Figure 11**

Side-stick controller



- Gimbal joint
- Roll artificial feels
- Pitch artificial feels
- Sensor boxes



## PILOT INTERFACES

### Side-stick

The central wheel was introduced in the car and the aircraft for two main reasons. The 'horse' effect: not having a horse to keep the road, it became necessary for the pilot to continuously hold the track, thus a double-hand control was necessary. This is no longer the case when a system is keeping the track without any manual input. We had put a 'horse' in our loop.

Designed initially for a direct handling of the control surface, the control column/wheel had to transmit quite high forces. When the surfaces are servoed, the natural friction and inertia of a lengthy mechanical linkage still have to be handled but the pilot's natural senses and operations would lead them to apply forces much too high for the required action and thus the necessary feel and protection have to be provided through an artificial feel system.

With the EFCS there is no longer a linkage to drive the controls and the protection is directly provided from a computerized limit to the output.

Therefore it was quite natural to consider the use of a 'side-stick', thus saving weight, volume and inertia (Figure 11).

### Force or Motion

Conceptually, the side-stick could be made in two different versions, one that works through actually moving the stick (motion) or one that reacts through forces applied to it without moving it significantly.

Several evaluations were performed worldwide. On the simulator (no load environment) the vote is 50/50, but as soon as the thing is flying there is unanimous favoring of a significant motion of the stick. Displacement transducers are simpler and more reliable than force transducers. On the A320 side-stick are, on each axis, 10 such displacement transducers! Our choice therefore was a centimetric motion side-stick. Note that the law of effort per degree of displacement is asymmetric in roll. Experience accumulated worldwide in the simulator and in flight tests highlights the difficulty to achieve a proper uncoupling between pitch and roll with a mini-stick in front of the pilot. This is no longer a problem with a side-stick. It is also experimentally shown and confirmed by airline experience with the control column/wheel, that there is no difficulty to control from right or left hand or in transition from one to the other. A side-stick provides the additional advantage of clearing

the pilot's view of the front panel (Figure 12).

The choice of a 'side-stick' was definitely confirmed with the flight experiments in Concorde and Airbus aircraft MSN003 (Figure 3).

The side-sticks are installed on the left and right forward lateral consoles. An adjustable armrest to facilitate the side-stick control is fitted to each seat. As there is no trim switch, the side-stick includes a datum adjust switch to vary the selected heading and vertical speed. A solenoid controlled by the Flight Guidance ('autopilot') computer freezes the stick in neutral position in AP mode. Nevertheless if the pilot applies a force above a given threshold, the stick becomes free and the AP disengages.

### Interconnection

After careful thought and tests on a flight simulator Airbus has chosen not to have a mechanical linkage between the sticks but an electronic mixing between signals emitted by the two sticks with the following logic:

below a certain threshold (1/4 displacement of both sticks) both orders are algebraically added, beyond this threshold the second stick to move through the position of the first keeps the full authority, and the first one is limited to 1/3 of its signal value (remaining 2/3 displacement is ineffective).

In order to substantiate its proposal Airbus had to review the operational reasons that could have lead to the request for a linkage. There are four main reasons which are by order of importance.

#### 1. To counter a 'dead man' input

(The 'dead man' may well be a book or any reason to jam a stick).

With two hands and the full body it was possible to sustain a quite high break force on a control wheel but this is no longer possible using one wrist. A rather low break force would therefore have to be considered to disconnect the mechanical link with the recurrent risk of disconnection in normal operation (see 2 below). With our proposal there is no longer a problem. In the worst case the remaining stick is left with two thirds of the full authority without additional effort.

#### 2. To counter a dangerous manoeuvre of the other pilot

With a linkage such a counter action is braked by the opposite effort and considerably slowed down if not stopped. With the 'mixing' the counter action is immediate and may be as efficient or smooth as desired.

### 3. To detect the use of the stick by the other pilot

With standard flight control the aircraft may move significantly without flight control input and also a significant input of the flight control may have no apparent effect on the aircraft (i.e. when countering the flaps or the engine trim change).

With the A320 Fly-by-Wire there is a consistent relationship between aircraft movement and stick input at least in the normal flight envelope below minimized turbulence effect: no input, no motion change. Therefore, the natural detection of roll or load change gives an unmistakable warning that the other pilot (or the AP) is activating the flight control and the stick linkage is not necessary.

### 4. Training

Although we have confirmed in the simulator that there still is a 'feeling' of the other input, it is quite clear that the 'mixing' of signals does not give the same quality of back-up as a fixed linkage coordination.

But is it necessary? We are building a much better flying control system, which is much easier to fly, which is much easier to teach and to learn. And indeed many of the line pilots have flown our experimental aircraft by using the left side-stick with a dead right control column, and we never had to re-activate the control column during any of these flights.

This fourth reason is thus of little significance and certainly not important enough to counter-balance the obvious advantages shown in the first three points. Therefore our conclusion is that from a pure operational point of view the proposed signal mixing is significantly better than any mechanical linkage.

### CERTIFICATION ISSUES

For any new aircraft certification, Airbus Industrie is now bound to Joint Airworthiness Requirement JAR 25 - Revision 10, as required by the major European Airworthiness Authorities.

No difficulties are expected to meet the level

of possibility required by JAR 25-1309 and the electrical redundancy requirements of JAR 25-1351.

### CONCLUSIONS

The EFCS as proposed is the result of a logical approach to maximum benefit from the modern technology now available. Benefits are to be found in all significant areas:

#### Safety

Elimination of stall, overspeed or over-stress are the real benefits of such a system. The optimum cockpit interface may at long last be designed. In addition, the possibility to achieve standard behaviour of the aircraft around the flight envelope, although not quantifiable, will most probably further improve the adequacy of pilot response.

#### Training

The possibility to offer the same handling characteristics whatever the aircraft type, is expected to reduce transition training cost by about 30%.

#### Maintenance cost

75% fewer LRU's, much easier troubleshooting and a drastic reduction in line maintenance adjustment procedures will lead to 40% maintenance cost reduction as far as ATA chapters 22 (EFCS) and 27 (Flight Control) are concerned.

#### Efficiency

Last but not least aircraft efficiency will be significantly improved. Considering aircraft of the same size and aerodynamic standard, a 600 kg weight saving has been computed and a fuel saving of about 5% is expected from proper use of the 'relaxed stability' potential.

The Fly-By-Wire concept is well proven and does not present any technical difficulty. The major difficulties are expected in the field of the natural and reasonable conservatism of Airworthiness Authorities and crew, but the necessary steps have been taken to overcome these difficulties in the natural way, that is in rationale, logic and by experiments/tests and simulations which prove that this concept is valid beyond any reasonable doubt.

Figure 12

A320 Cockpit (September 1984 configuration)



# FQI SYSTEM

## INSTALLED ON A300-600 AND A310



by Hans Fischer  
Supervisor Powerplant  
Technical Support

Although based on the same principle as the A300 FQI system, that is measurement of capacitance using the dielectric properties of fuel and air, the A300-600/A310 systems benefit from the latest technological developments to further

increase the accuracy of measurement of fuel load. Its most important feature, and that which mainly distinguishes it from the A300 installation, is the addition of the "Cadensicon"\* sensor and an associated computer program.

The objectives of an FQI system are to accurately measure fuel load and consequently, to minimize surplus fuel loads and thereby to conserve fuel. Airbus Industrie required that this system be of the latest generation design, providing for high accuracy measurement, low component weight, high reliability, redundancy and good maintainability. These objectives have been achieved by incorporation of an original method to estimate fuel measurement errors by relating density to permittivity. This is achieved by the installation of a Cadensicon sensor (Figure 2), by using microprocessors in the digital processing of measurement and by using entirely solid state components where possible.

Although the basic principles of the system were explained in the previous edition of FAST (No.2/84) it is perhaps worth recalling them here. Aviation fuel having a dielectric constant approximately twice that of air, if a cylindrical capacitor is placed vertically in the tank then the capacitance varies with the height of fuel in the cylinder (the height of fuel in the tank). The FQI system is thus based upon the capacitance variation of the tank probes relative to their immersion in fuel. Since the dielectric constant or permittivity of fuel varies proportionally with its density, it is convenient to calibrate the gauge in mass of fuel.

\***Ca-densi-con** is derived from the following

**Ca** = K the dielectric constant (permittivity)

**densi** = D density

**con** = comparison

A **dielectric** is a non conductor of direct electric current.

**Permittivity** is the ability of a dielectric to store electrical potential energy under the influence of an electric field measured by the ratio of the capacitance of a condenser with the material as dielectric to its capacitance with **vacuum** as dielectric.

### HOW IT WORKS

If the relationship between K (permittivity) and D (density) was constant, the task of measuring fuel quantity accurately would be simple. In practise however a certain dispersion exists which results in an intrinsic error of the capacitance measuring system. Intertechnique, who is one of the vendors responsible for the FQI system on A300-600 and A310, has taken measurements of many different grades of fuel from different parts of the world under varying conditions and as a result has been able to define an average law which is a gently curving band (Figure 1). The fact that the result is a curve rather than a straight line is due to the fuel scatter effect: the relationship of K to D between different fuel samples is only nearly constant. However for a specific sample, a fuel load in an aircraft for example, the relationship of K to D remains constant with varying temperatures.

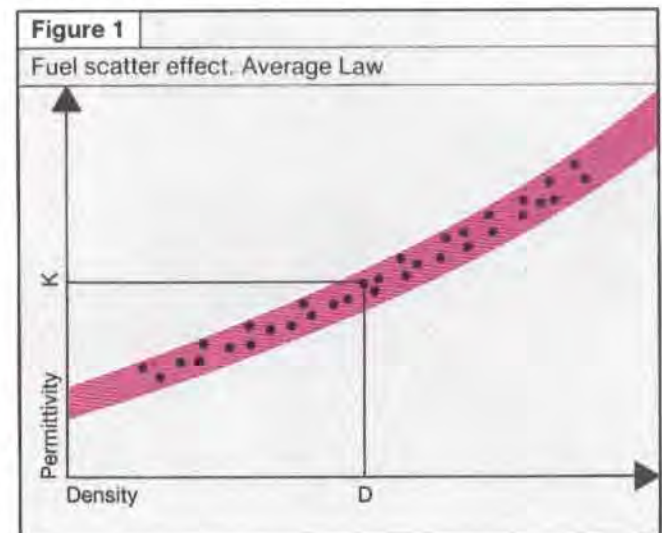

Figure 2

Cadensicon sensor

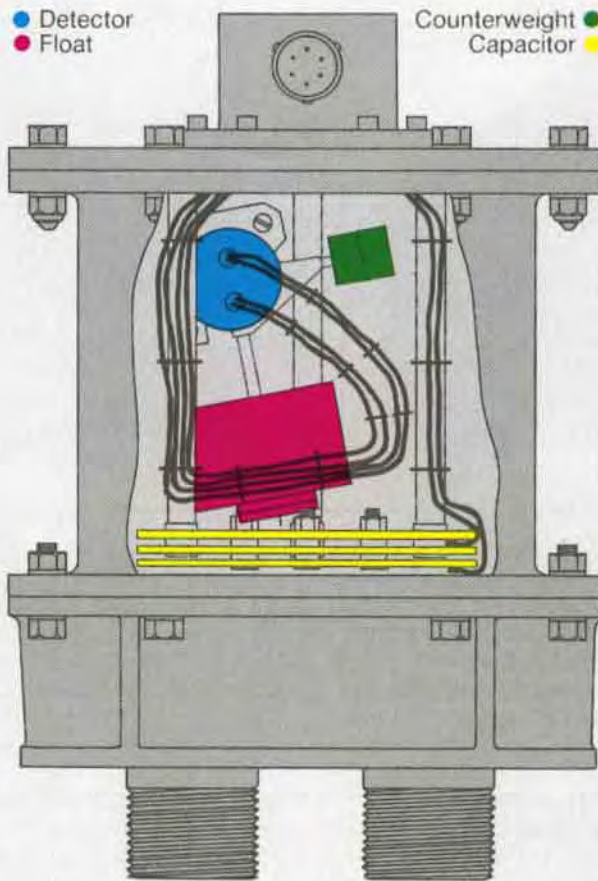
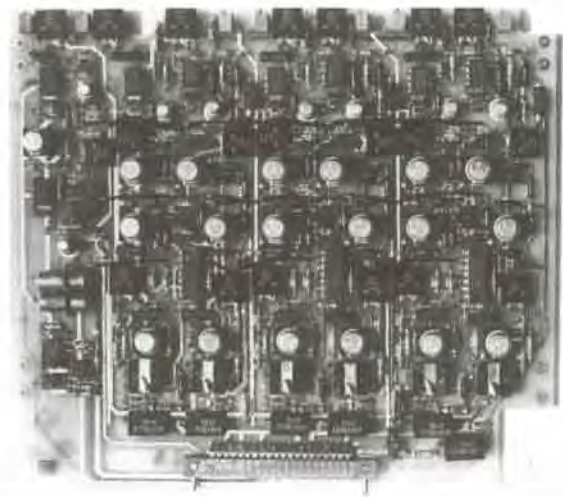
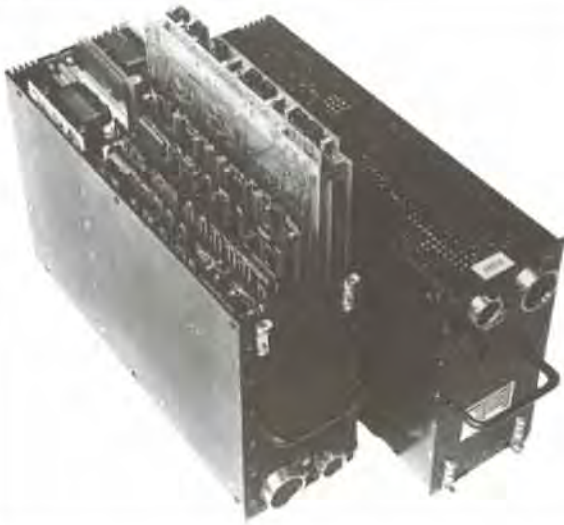

Figure 3

FQI Computer

FQI Computer board



The intrinsic error mentioned above can be partly corrected by using a compensator probe, one per tank, which is connected to a capacitor constantly immersed in fuel and which varies only with permittivity. This compensator probe provides a correction factor to the fuel probes in its tank. The fuel probes then transmit their corrected fuel quantity measurement to the system computer. This compensator system provides some compensation of the error, due to fuel scatter, but does not eliminate it.

**FUEL SCATTER COMPENSATION :-  
CADENSICON SYSTEM**

The main means of reducing the error is with a computer program which uses as a key the infor-

mation provided to it by the Cadensicon sensor. The cadensicon-sensor measures K and D separately as fuel enters the tank. K is measured electrically only and D is measured mechanically by a float, sensitive to the density of the fuel, which by its movement transmits an electrical signal. The information is fed to the computer which calculates the constant which will fall within the average curve band. As the temperature varies within the tanks and with flight duration, the constant would move in a straight diagonal line. However, to provide accurate indication of fuel quantity it must follow the average curve. The FQI system computer provides this deviation based on the key

Figure 4

FQI system components

**Flight deck**



**Electronics bay**

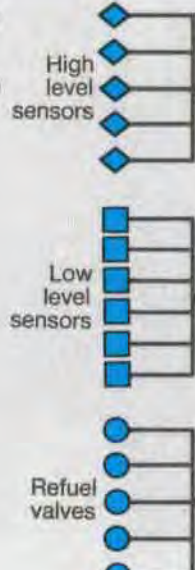
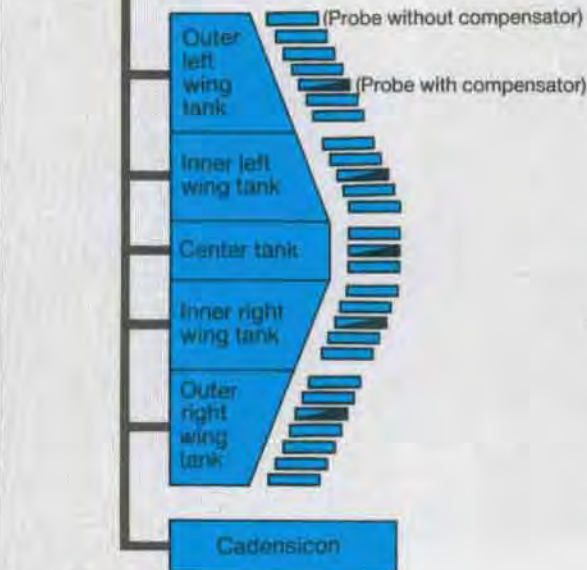
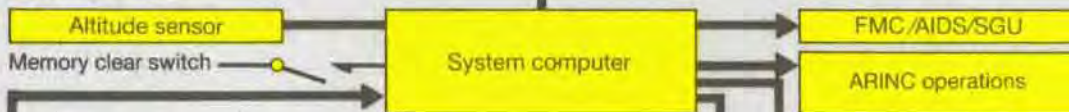

**Fuel tanks**

**Refuel panel**

input from the Cadensicon sensor. The computer can also calculate a mean (K-D) value from remaining fuel and the replenished fuel and take account of a situation where, for example, the outer tanks remain full from a previous flight and therefore could have a different (K-D) value to the fuel in the other tanks.

**THE SYSTEM**

The FQI computer is the heart of the system (Figure 3 & 4). It has analog and digital sections. The various system sensors are supplied with excitation signals by the analog section. Modified versions of these signals are fed back from these sensors and processed in the analog section. They are then converted into digital form and fed into two identical channels. Each channel has a microprocessing module which analyses and interprets the data for the various indicators and systems and manages numerous verifications of the system computer and components.

The computer also performs built-in tests, supplies diagnostic information and modifies its response as conditions and information changes.

**IN-SERVICE EXPERIENCE**

Soon after the A310 entered service there were complaints of fuel quantity over-reading on ECAM by up to 700 kg, inconsistent over-reading between aircraft, frequent triggering of failure code 5.05 (Cadensicon empty). Investigation revealed that incomplete filling of the Cadensicon sensor during refuelling was the major contributor to these faults. As a result erroneous K and D values were transmitted to the computer. Temporarily the computer was fed with fixed values until the Cadensicon sensor was modified. The modification consisted of improving fuel flow conditions through the units. At the inlet port

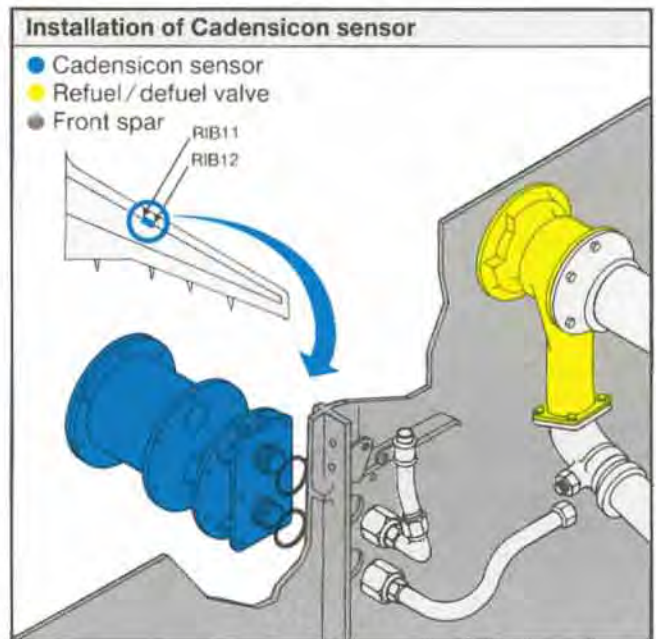

conditions through the units. At the inlet port a restrictor now provides a correct path for the fuel, the flow of which is also smoothed. A weir has been added to the outlet port to ensure complete filling.

Tests with reinstated K and D values to the system computer were successfully completed during 1984 on an Airbus A310 test aircraft and on some A310's in-service. Figure 5 shows the significant improvement of the FQI calibration curve subsequent to this implemented change. As an average, the accuracy over the fuel load range is now within 0.5 % or less, which is an excellent result by any standard.

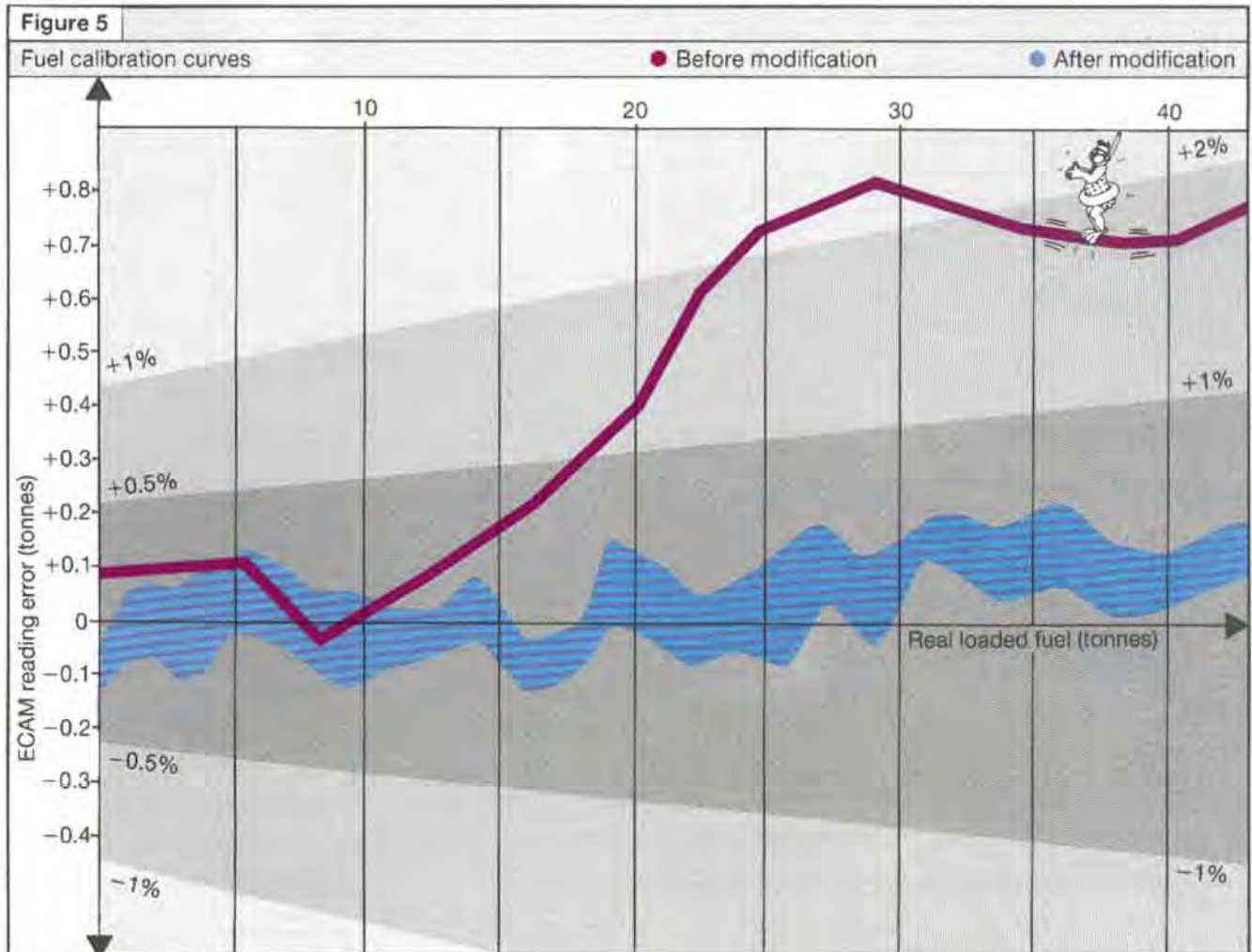

**AIRBUS FIELD SERVICE INFORMATION**

<b>AIRLINES</b>	<b>REPRESENTATIVE</b>	<b>ADDRESS</b>
ATLAS	<b>Volker GELLER</b>	c/o Deutsche Lufthansa, Building 116/452, D-2000 Hamburg 63, Postfach 300, Federal Republic of Germany
AIR AFRIQUE (RK)	<b>Jean-Yves LE PAYEN</b>	c/o Air Afrique, Centre Industriel de Dakar, BP 8165 Dakar Yoff, Sénégal
AIR ALGERIE (AH)	<b>Alain VICENTE</b>	c/o Direction Technique Air Algérie, Aéroport H. Boumedienne, Dar El Beida, République Démocratique Algérienne
AIR FRANCE (AF)	<b>Christian GINISTY</b>	c/o Air France, Zone d'Entretien DM / QN, BP 10253, 95704 Roissy-Charles de Gaulle, France
AIR INDIA (AI)	<b>Mario TAVERNA</b>	c/o Air India, Engineering Dept., Technical Building, Old Airport, Bombay 400029, India
AIR INTER (IT)	<b>Gérard GRENON</b>	c/o Air Inter DM / QD, BP 225, 94396 Orly-Aérogare, France
AIR JAMAICA (JM)	<b>Pascal COMBEAU</b>	Post Office, Norman Manley Airport, Kingston, Jamaica WI
ALITALIA (AZ)	<b>Yves MARY</b>	c/o Alitalia, Direzione del Materiale, Aeroporto Leonardo da Vinci, 00050 Roma Fiumicino, Italia
BRITISH CALEDONIAN AIRWAYS (BR)	<b>Anthony JONES</b>	c/o British Caledonian Airways, 3rd Floor, Hangar West, Caledonian House, Crawley, West Sussex RH10 2XA, United Kingdom
CHINA AIRLINES (CI)	<b>Manfred NEUMANN (acting)</b>	c/o China Airlines, PO Box 20, Chiang Kai Shek Intl. Airport, Taoyuan, Taiwan (ROC)
CYPRUS AIRWAYS (CY)	<b>Jean-Pierre DO</b>	PO Box 849, Larnaca, Cyprus
EASTERN AIRLINES (EA)	<b>Manfred THOMSEN</b>	c/o Eastern Airlines, PO Box 660797, Miami Springs, Florida 33166, USA
EGYPTAIR (MS)	<b>Uwe KLANN</b>	Box 2701, El Horrieh, Helipolis, Cairo, Egypt
GARUDA INDONESIA AIRWAYS (GA)	<b>Ajith FRANCIS-JOSEPH</b>	Garuda Maintenance Center, Room 209, Kemayoran Airport, PO Box 3760, 10002 Jakarta, Indonesia
HAPAG-LLOYD FLUG (HF)	<b>Günter STOLL</b>	c/o Hapag-Lloyd Flug, D-3000 Hannover 42, Flughafen Strasse 10, Flughafen Postfach 420240, West Germany
IBERIA (IB)	<b>Jean PUGNIER</b>	c/o Iberia, Oficina de Correos, Aeropuerto de Barajas, 28042 Madrid, Spain
INDIAN AIRLINES (IC)	<b>Dieter KINDERMANN</b>	c/o Indian Airlines, New Engineering Complex, Sahar Bombay 400099, India
IRAN AIR (IR)	<b>Jens WIND</b>	c/o Iran Air, Engineering and Maintenance Dept., Mehrabad Airport, Teheran, Iran
KLM ROYAL DUTCH AIRLINES (KL)	<b>Manfred MÜCKE</b>	c/o KLM Royal Dutch Airlines, 1117 Schiphol Airport Oost, Building 404, Room 310, Amsterdam, Holland
KOREAN AIR (KE)	<b>Eberhardt KUNBERGER</b>	c/o Korean Air, Kimpo International Airport, Seoul, South Korea
KUWAIT AIRWAYS (KU)	<b>Max EICHNER</b>	c/o Kuwait Airways Corporation, Engineering Dept, PO Box 528, Kuwait
LUFTHANSA (LH)	<b>Christoph DORMANN</b>	c/o Lufthansa, Abteilung FRA-IF8, Flughafen, D-6000 Frankfurt/Main 75, Federal Republic of Germany
MALAYSIAN AIRLINE SYSTEM (MH)	<b>Christian SENAT</b>	c/o Malaysian Airlines System, International Airport of Kuala Lumpur, Subang, Selangor, Malaysia
MARTINAIR (MP)	<b>Manfred MÜCKE</b>	c/o KLM Royal Dutch Airlines, 1117 Schiphol Airport Oost, Building 404, Room 310, Amsterdam, Holland
NIGERIA AIRWAYS (WT)	<b>Charles MELKONIAN</b>	Nigeria Airways, PO Box 136 Airways House Murtala Mohammed Airport, Lagos, Ikeja, Nigeria
OLYMPIC AIRWAYS (OA)	<b>Jean-Claude HUG</b>	c/o Olympic Airways, Hellinikon Airport, Athens, Greece
PAKISTAN INTERNATIONAL AIRLINES (PK)	<b>Robert LIPSCOMBE</b>	c/o Pakistan Airlines, Director Engineering and Maintenance, Karachi Airport, Pakistan
PAN AMERICAN WORLD AIRWAYS (PA)	<b>Johannes SPRINGER</b>	Pan American Airways, J.F.K. International Airport Building 208, Room 1330B, Jamaica N.Y. 11430 USA
PHILIPPINE AIRLINES (PR)	<b>Michael RENKEN</b>	CPO Box 8088, Paranaque, Philippines
SABENA (SN)	<b>Robert CISTAC</b>	c/o Sabena, T. Ent. Av., Hangar 41, 1930 Zaventem, Belgium
SAUDI ARABIAN AIRLINES (SV)	<b>Johannes CORDIER</b>	c/o CC 833, PO Box 167, Jeddah, Saudi Arabia
SCANDINAVIAN AIRLINES SYSTEM (SK)	<b>Peter REHFELD</b>	c/o Scandinavian Airlines System, Maintenance Base Arlanda, STOZT, S.19045, Stockholm / Arlanda, Sweden
SINGAPORE AIRLINES (SQ)	<b>Anton GENSBIHLER</b>	c/o Singapore Airlines, Engineering Division, PO Box 501, Changi Airport, Singapore
SOUTH AFRICAN AIRWAYS (SA)	<b>Charles MAILLARD</b>	c/o South African Airways, PO Box Jan Smuts Airport 1627, Room 216/7 B707 Annex, Johannesburg, Republic of South Africa
SWISSAIR (SR)	<b>Gerd BAHR</b>	c/o Swissair Engineering, Dept. T1, CH 8058 Zürich Airport, Switzerland
THAI AIRWAYS INTERNATIONAL (TG)	<b>Patrice FERIAL</b>	c/o Thai Airways International, Technical Dept, Don Muang Airport, Bangkok, Thailand
TOA DOMESTIC AIRLINES (JD)	<b>Bernd JUERGENS</b>	c/o TOA Domestic Airlines, DA 1-2 Sogo Building, 7-1,1 Chome Hanedakuko, Ohta-Ku, Tokyo, Japan
TRANS AUSTRALIA AIRLINES (TN)	<b>Jean-Marie VIVIES</b>	c/o Trans Australia Airlines, Melbourne Airport, 3045 / VIC, Box No 107, Melbourne, Australia
TRANS EUROPEAN AIRLINES (HE)	<b>Robert CISTAC</b>	c/o Sabena, T. Ent. Av., Hangar 41, 1930 Zaventem, Belgium
TUNIS AIR (TU)	<b>Christian MASSOL</b>	c/o Tunis Air, Division Entretien, Department Technique, Aeroport de Tunis-Carthage, Tunisie
VARIG AIRLINES / CRUZEIRO DO SUL (RG / SC)	<b>Jean-Louis PUYDENUS</b>	c/o Varig SA, Rua de Hangares S / N Galeo, CEP 21941 Rio de Janeiro, Brazil
VASP (VP)	<b>Michel BOYER</b>	Edificio VASP, Hangar 1, Aeroporto de Congonhas Sao Paulo, SP 04695, Brazil

LOCATION	TELEPHONE	TELEX	SITA
HAMBURG	49 (40) 59 102239	212277	HAMXTLH
DAKAR	221 (-) 200303 / Ext. 283	-	DKRIERK
ALGIERS	213 (-) 765252	54093	ALGTZAH
PARIS	33 (1) 8642235	220908	CDGASAF
BOMBAY	91 (22) 6121650 / Ext. 296	0112427	BOMEAAI
PARIS	33 (1) 6869823	200337	ORYASAF
KINGSTON	1 (809) 9248793	2389 Airbus Reps.	KINZMJM
ROME	39 (6) 60102253	43610036	FCOMZAZ
LONDON (GATWICK)	44 (293) 582146	-	LGWEHBR
TAIPEI	886 (33) 834410	32222	TPEMMCI
LARNACA	357 (41) 23306 Ext 2529	2407 CALENG	-
MIAMI	1 (305) 8878717	51-5681	-
CAIRO	20 (2) 437781	-	CAIESMS
JAKARTA	62 (21) 682794	49103	JKTMZGA
HANOVER	49 (511) 7303293	921298	HAJEAHF
MADRID	34 (1) 2054323	48154 ABUSE	-
BOMBAY	91 (22) 6124328	011-71593	BOMYCIC
TEHERAN	98 (21) 9112773	212795	THRMBIR
AMSTERDAM	31 (20) 418951	18707 ASDFS	SPLTSKL
SEOUL	82 (2) 6630111 / Ext. 3644	27526	SELXSKE
KUWAIT	965 (-) 742193	-	KWIBAKU
FRANKFURT	49 (69) 6963947	411988	FRAIFLH
KUALA LUMPUR	60 (3) 768555 / Ext. 2470	MA 37276	KULBAMH
AMSTERDAM	31 (20) 418951	18707 ASDFS	SPLTSKL
LAGOS (IKEJA)	234 (1) 900470 / Ext. 117	21100 (DURBAR HOTEL)	
ATHENS	30 (1) 9818581	216488	ATHEYOA
KARACHI	92 (21) 4845290	2832	KHIVEPK
NEW YORK, JFK	1 (718) 632.2225		NYC MNPA
MANILA	63 (2) 8316541	23240	MNLEUPR
BRUSSELS	32 (2) 7214315	23931	BRUMOSN
JEDDAH	966 (2) 6842863	-	JEDETSV
STOCKHOLM (ARN)	46 (8) 7803838	22263	STOZTSK
SINGAPORE	65 (-) 5423333 / Ext. 6070	35416	-
JOHANNESBURG	27 (11) 9702163	429059	-
ZÜRICH	41 (1) 8127727	52407	ZRHZESR
BANGKOK	66 (2) 5238391	82890	BKKZUTG
TOKYO (HANEDA)	81 (3) 7476004	(7810) 2466274	-
MELBOURNE	61 (3) 3382771	31320	-
BRUSSELS	32 (2) 7214315	23931	BRUMOSN
TUNIS	216 (1) 238000 / Ext. 2054	13557	TUNTITU
RIO DE JANEIRO (GIG)	55 (21) 3932525 / Ext. 159	(021) 21765	GIGMFRG
SAO PAULO (CGH)	55 (11) 5337011 / Ext. 361	-	SAOMZVP



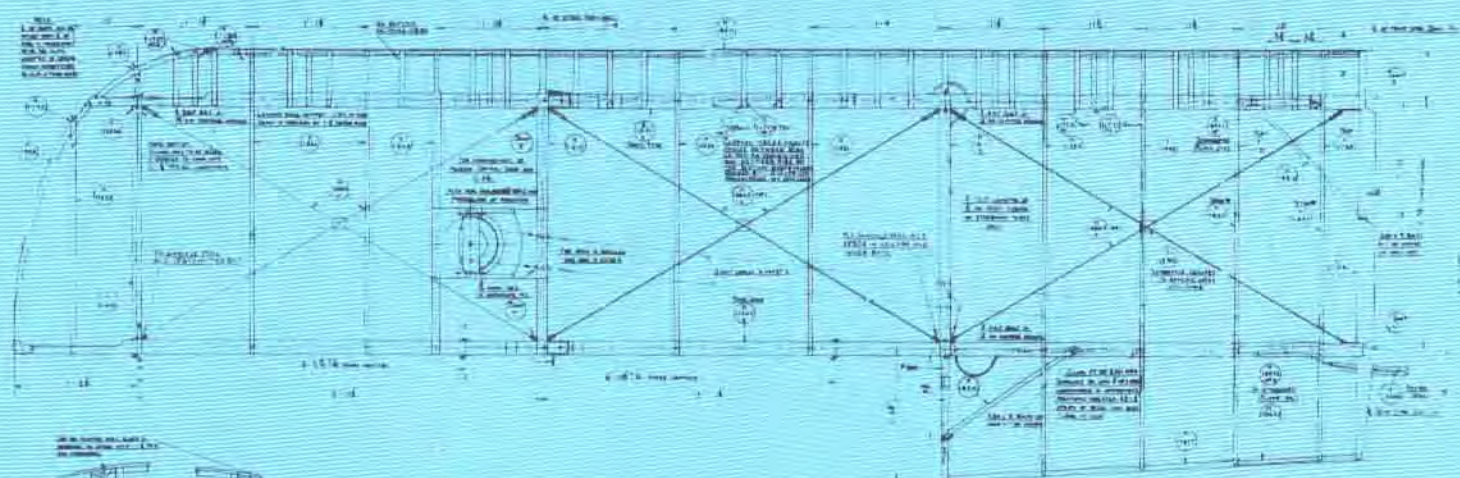

# WHAT IS IN A WING?

Sixty years ago the designers of the de Havilland DH 60 Moth were struggling with structures in wood, aluminium tube and fabric. Today their descendants in the same company have other materials to think about. Sixty years ago, there were no worries about the comparison of lithium alloys with carbon fibres, however weighing the merits of spruce over walnut or ash no doubt required as much consideration. Corrosion was not much of a problem but what about water ingress and the integrity of glued joints? Maybe not so much has changed after all.



# KOREAN AIR

1975-1985

Ten years of unbeatable reliability

99.8%

Airbus Support Division salutes the remarkable dispatch reliability figure achieved by Korean Air throughout 1984 for its entire Airbus fleet operations. With the reliability improvement program defined and offered by Airbus Support Division to Airbus operators, this unprecedented level of dispatch reliability is economically achievable by all.

